

# 84N5 Series

## Universal Sheet Metal Press Shop Gripper



DESTACO's 84N5 sheet metal gripper is the universal solution for press shop gripping applications. The 84N5 gripper accelerates your press tending productivity with a lighter, faster and highly flexible gripper that can accommodate most press shop needs. The 84N5 features easy in-field jaw reconfiguration, adjustable opening angle, multipoint sensing and minimal field maintenance.

Developed for high-speed automation now you can increase your productivity using lighter tooling weighing as little as 0.68kg with an actuation speed of 70ms and a grip force up to 1200N. The small footprint of this gripper will fit into existing applications for easy system upgrades.

Designed and tested for long life, this patented gripper requires minimal maintenance. A variety of sheet metal thickness tips, field changeable jaw kits, multiple blank and double blank sensing solutions provide extreme versatility. With the wide offering of mounting options, the 84N5 is a universal press shop gripper solution.



US Patent #10549431

### Product Highlights/Options

- Full range adjustable jaw opening
- Interchangeable jaws
- Fast on-site configuration changeover
- Optional multipoint sensing
- Easy field maintenance



GRIPPING

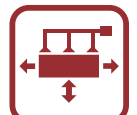

PICK AND PLACE

### Features, Markets and Applications

<p>STRENGTH</p>	<ul style="list-style-type: none"> <li>• Powerful grip force up to 1200N at 5 bar</li> <li>• Self-lock jaws grips sheet metal securely if air pressure is lost</li> <li>• Integrated hardened steel impact plates protects gripper body from panel impact</li> </ul>	<p>AUTOMOTIVE</p>	<p>STAMPING</p>
<p>PERFORMANCE</p>	<ul style="list-style-type: none"> <li>• Ultra-fast 70ms actuation for high speed press shop automation</li> <li>• Multipoint sensing for blank, double blank, full open, and full close detection</li> <li>• High durability with minimal maintenance</li> </ul>	<p>CONSUMER</p>	<p>ASSEMBLY</p>
<p>INTERCHANGEABLE</p>	<ul style="list-style-type: none"> <li>• Quick changeover from single to double tip configurations</li> <li>• On-demand opening angle adjustment</li> <li>• Wide selection of interchangeable mounting solutions</li> </ul>	<p>AEROSPACE</p>	<p>CNC MACHINING</p>
		<p>PACKAGING</p>	<p>FIXTURE/TEST</p>

\*When compared with our closest competition

# ACCELERATE® PRESS SHOP GRIPPER

## 84N5 Series Sheet Metal Grippers



The **84N5 Universal Sheet Metal Gripper** is available in three jaw types. The modular design allows the jaws to be exchanged in the field quickly and easily with the use of a single allen wrench.



**Multipoint Side Mount Sensing:**  
for open/closed, single and double blank sensing

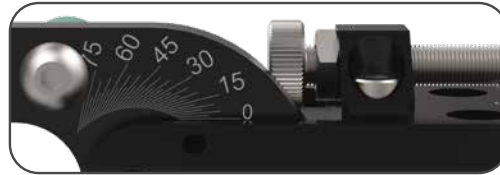

**Optional Angle Adjustment Kit:**  
for multiple jaw openings in one gripper

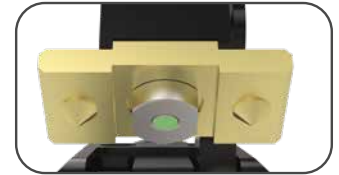

**Optional In-Jaw Sensor**  
for part present sensing

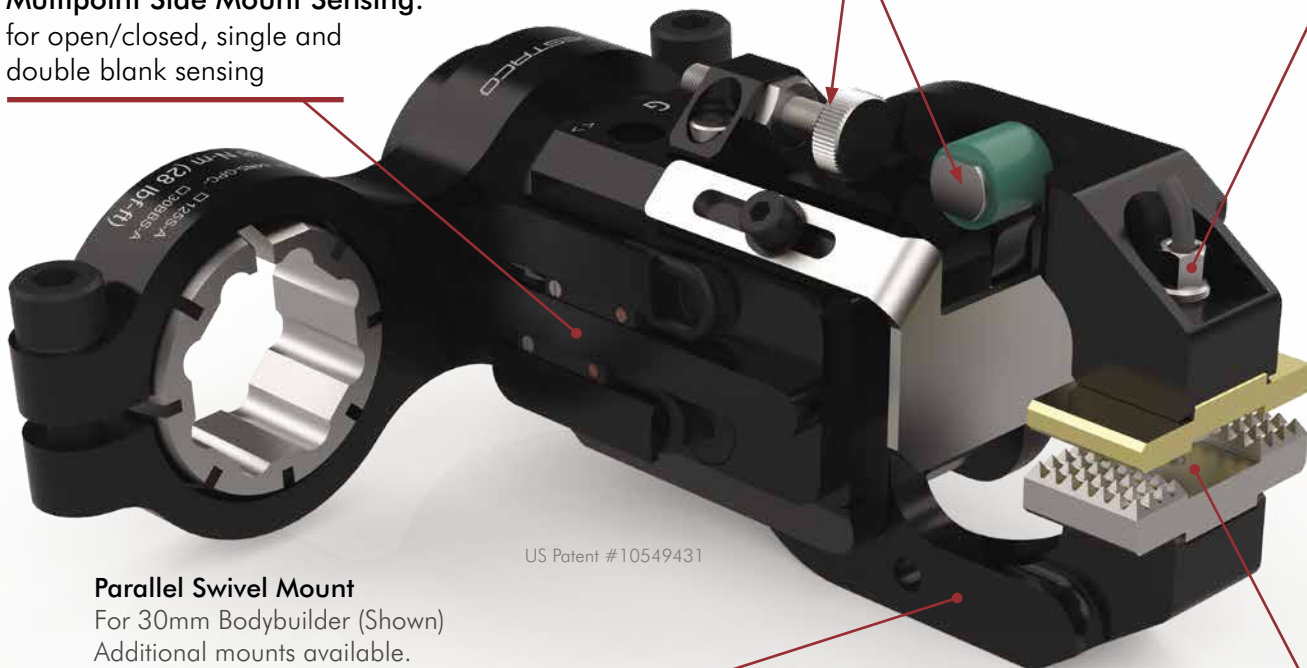

US Patent #10549431

**Parallel Swivel Mount**  
For 30mm Bodybuilder (Shown)  
Additional mounts available.

**84N5-X-075-FA**  
Fixed Lower Jaw

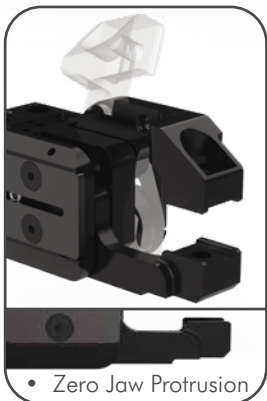

• Zero Jaw Protrusion

**84N5-X-075-DA**  
Double Open Jaw

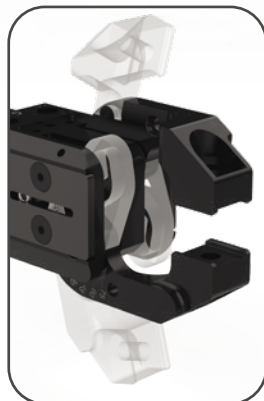

**84N5-X-075-PA**  
90° Jaw Configuration



**Interchangeable Jaw Tips:**  
Single & double cone or serrated style tips can be used in different configurations for different contact points and part thicknesses

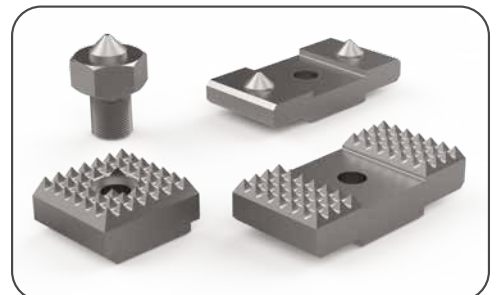

# ACCELERATE® PRESS SHOP GRIPPER

## 84N Series Jaw Options | Flexible and Adjustable

### Field Adjustable Jaw Opening

The 84N5 sheet metal gripper with angle adjustment kit option installed allows jaw opening angle to be adjusted quickly in the field from 15° up to maximum 75° simply with the turn of the stopper.



**Convenient Angle Marking**  
For easy identification of jaw opening angle

### 84N5-X-ADJ-XX

Jaw Opening  
Set to 75°  
(Closed)

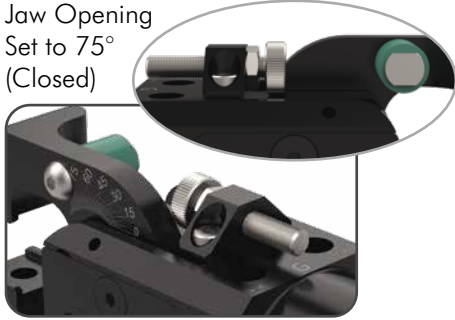

### 84N5-X-ADJ-XX

Jaw Opening  
Set to 75°  
(Open)



### 84N5-X-ADJ-XX

Jaw Opening  
Set to 15°  
(Open)



### Interchangeable Jaw Tips:

To allow the handling of multiple part thickness



Part Thickness  
Range  
Option 1  
0.4 - 1.0mm



Part Thickness  
Range  
Option 2  
1.0 - 1.6mm

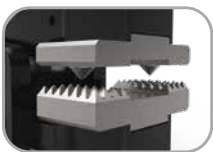

Part Thickness  
Range  
Option 3  
1.6 - 2.2mm



Part Thickness  
Range  
Option 4  
2.2 - 2.8mm

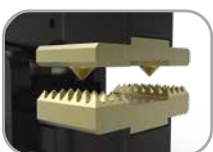

Part Thickness  
Range  
Option 5  
2.8 - 3.4mm

### Adjustable Sheet Stop

The included sheet stop can also be adjusted in the field to change the jaw depth



### Optional Mounts (Sold Separately)

Offered in applecore, ball, and swivel options for use in most applications



Side Mount  
Apple Core  
19mm  
20mm



Side Mount  
Ball Mount  
1.125in  
32mm



Parallel Swivel  
Mount  
1.00in/25mm  
1.25in/30mm BB



Rear Ball Mount  
32mm Ball



Rear Flange Mount  
35.1 x 57mm  
Mounting pattern



Rear Swivel Mount  
25mm

DESTACO's **84N5 Series** is latest addition to the family of Accelerate® Press Shop Sheet Metal Grippers



DESTACO 84N Series Accelerate® Press Shop Sheet Metal Grippers are up to:

**60% lighter\*** (0.27-0.68kg)

**40% smaller\*** foot print

**62% faster\*** actuation (33-70ms)

**100% DESTACO** innovation

Specification	Unit	84N1/84N2	84N5
Grip Force at 5 bar	N	Up to 1000	Up to 1200
Weight (FA jaws - no tips)	Kg	0.27	0.68
Size L x W x H (Open)	mm	110 x 43 x 64	149 x 46 x 95
Actuation Time	ms	33	70
Minimum Operating Pressure	bar	3	4
Opening Angles		30°, 45°, 60°, 75°	75°, ADJ (15°-75°)
Piston Ø	mm	25	32
Air Consumption/Cycle	L	.015	.036

\*When compared with our closest competition

Dimensions and technical information are subject to change without notice.

GERMANY  
+49-6171-705-0  
europe@destaco.com

UNITED KINGDOM  
+44-1902-797980  
uk@destaco.com

NETHERLANDS  
+31-297285332  
benelux@destaco.com

THAILAND  
+66-2-326-0812  
asia@destaco.com

USA  
+1-888-DESTACO  
+1-248-836-6700  
northamerica@destaco.com

FRANCE  
Tel: +33-4-7354-5001  
france@destaco.com

SPAIN  
+34-936361680  
spain@destaco.com

CHINA  
+86-21-6081-2888  
china@destaco.com

INDIA  
+91-80-41123421-426  
india@destaco.com