

## Workholding Clamping Solutions

### Manual and Pneumatic Clamping Products

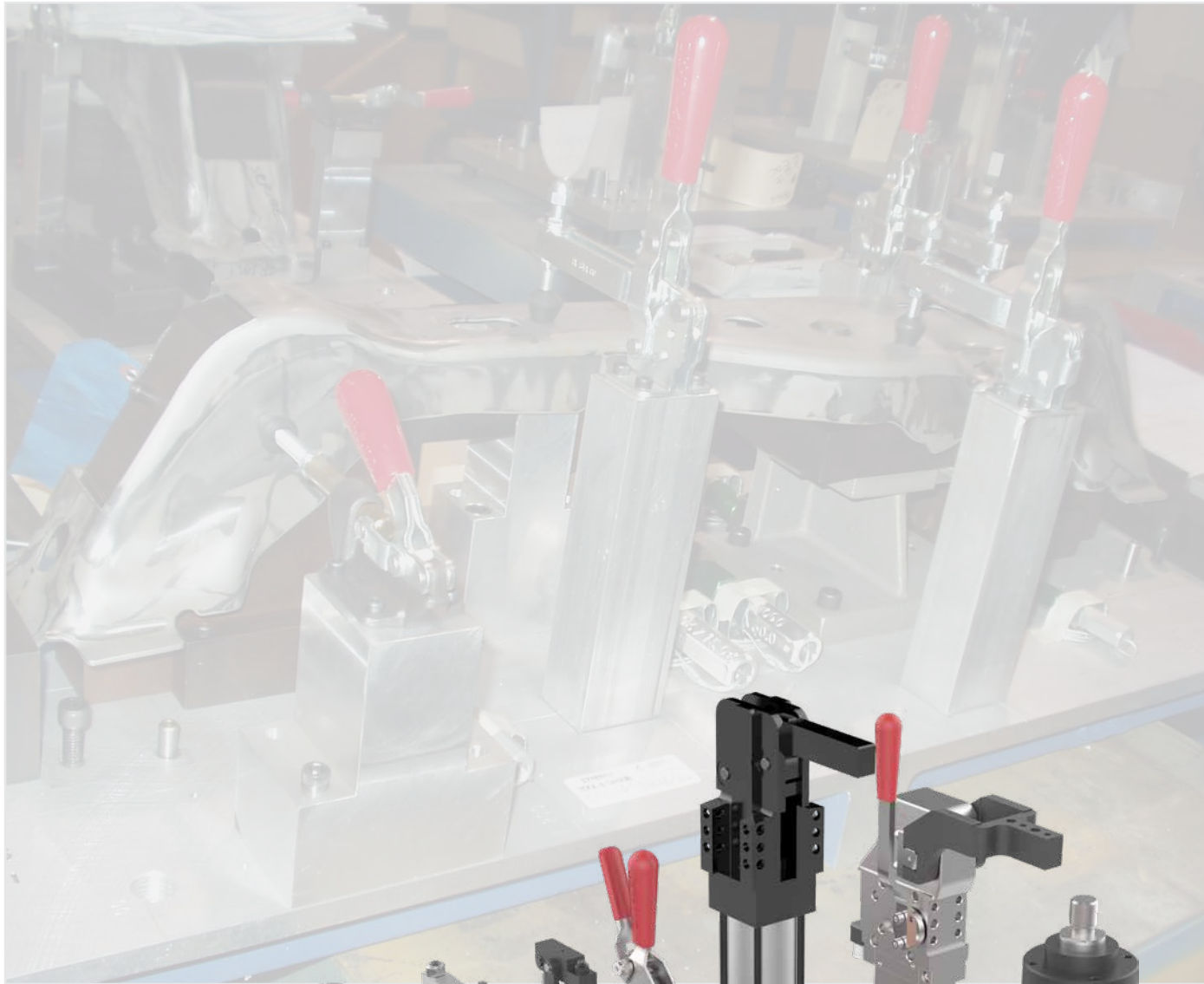

## ABOUT DESTACO

### Built on a Strong Foundation



Destaco, a Dover company, is a global leader in the design and manufacture of high-performance automation, workholding and remote-handling solutions. The company serves customers in a variety of end-markets, including the automotive, life sciences, consumer packaged goods, aerospace, industrial and nuclear sectors.

Built on a legacy of more than 100 years, Destaco offers a comprehensive portfolio of products designed to engineer precise movement, placement and control solutions that drive productivity and uptime for manufacturers around the world. The Destaco family of products consists of industry-leading brands such as Destaco Manual Clamps, Power Clamps, and End Effectors; CAMCO™ and Ferguson™ Indexers; Robohand™ Grippers; and CRL™ Manipulators and Transfer Ports.

Destaco is based in Auburn Hills, Michigan, U.S.A. The company has more than 800 employees with 13 locations, in 9 countries, across the Americas, Europe and Asia.

Destaco is part of Dover Corporation, a diversified global manufacturer with annual revenues of \$7 billion. The company delivers innovative equipment and components, specialty systems and support services through four major operating segments: Energy, Engineered Systems, Fluids, and Refrigeration & Food Equipment. Headquartered in Downers Grove, IL, (NYSE: DOV)

More information is available at [destaco.com](http://destaco.com) and [dovercorporation.com](http://dovercorporation.com)

## Focusing all our Resources

### New Product Development

Destaco has dedicated resources to design and build the next generation of products and solutions

### Customer Service and Technical Support

Destaco has industry leading global support to address any product and application concerns you may have

### Design Tools

Destaco provides an extensive CAD library, sizing software, and online tools to support our global customers



## Our Insight Working for You

### Application Engineering

We utilize our expertise and complete portfolio of products to create solutions that fit our customers' needs and applications

### Custom Solutions

If our off-the-shelf solutions don't fit, we will partner with our customers to develop products that will



## Manual and Pneumatic Toggle Clamps and Swing Clamps

### Designed to Hold Securely

#### Markets



#### Applications

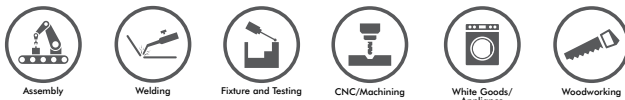

## Pneumatic Power Clamps

### Clamp with Confidence

#### Markets



#### Applications



### CLICK OR SCAN

To view PDFs of the following literature:



Full Catalog



Visual Selection Guide

## Why Destaco Clamps?

As the original patent holder of the toggle clamp, Destaco continues to develop toggle clamps designed to last for several years of service. While providing a diverse offering of clamping actions, ease of use and safety remains central to our product development.

Destaco continues to be innovator of several industry firsts, and have many active US and international patents

- Ergonomic handles for greater operator comfort and control
- Our safety link helps prevent accidental injury during opening
- Exclusive handle design gives more clearance between handle and bar when clamp is fully open

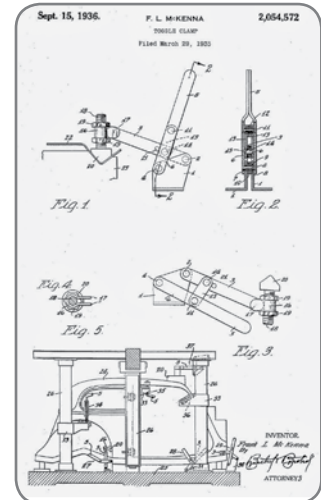

## Destaco Toggle Lock Plus

This is an optional locking release lever that helps ensure that the over-center locking condition is maintained. Adding this feature expands the range of applications Destaco clamps can be used.

- Optionally available for increased safety
- Locks clamp in closed, extended or latched position
- No accidental or unintentional opening



## Stainless Steel Models

Destaco offers toggle clamp models fabricated with corrosion, chemical and heat resistant stainless steel. These clamp models are used in many applications where corrosion is a problem

- Smooth surfaces without burrs
- Rivets made of stainless steel
- Stainless steel spindles with hex heads

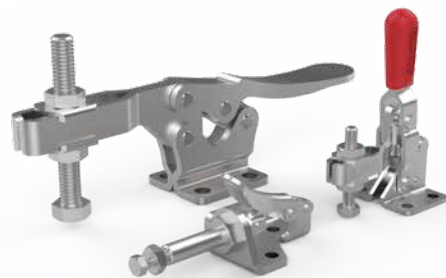

## Heavy Duty Clamping

Destaco offers heavy-duty versions of nearly every clamp type in its portfolio. These models are designed to push the upper limits of performance with very high holding capacities and withstand harsh manufacturing environments.

- Hardened steel pivot pins and bushings provide long life
- High strength forged clamping arms and hardened plungers
- Weldable clamp models available.



## Vertical Hold Down Action Clamps

**Holding capacities: 100lbf up to 6000lbf**

The vertical hold down clamps are identified by their vertical handles. The hold down bar (also called the clamping bar) exhibits a minimum 90 degree opening angle.

- Solid or "U" shaped clamping arm
- Straight or flange base mounting
- Stainless steel and heavy-duty models
- Optional T-handle
- Destaco® Toggle Lock Plus.



100+ Models Available



"U" Bar for adjustable spindle location



"S" Bar for fixed clamping and customized attachments

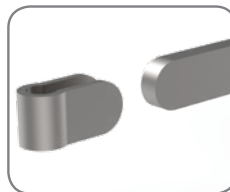

Flange Base Mount for secure surface mounting



Straight Base Mount for blade mounting



## Horizontal Hold Down Action Clamps

**Holding Capacities: 60lbf up to 2400lbf**

The outstanding characteristic of the Horizontal Hold down clamp is the low height design. Unlike the movement of the vertical clamps, the horizontal clamps move in opposite direction.

- Solid or "U" shaped clamping arm
- Straight or flange base mounting
- Stainless steel and heavy-duty models
- Destaco® Toggle Lock Plus.



70+ Models Available

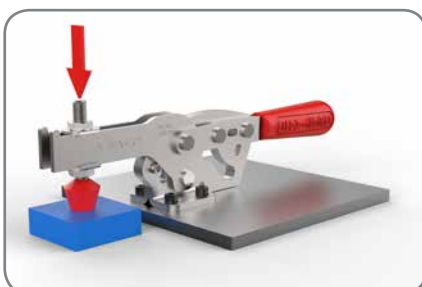

## STRAIGHT LINE ACTION AND PULL ACTION CLAMPS

### Straight Line Action (Plunger) Clamps

**Holding Capacities: 100lbf up to 16000lbf**

**Plunger Travel: 0.63in up to 4.00in**

The handle is easy to operate and moves the plunger of the clamp in and out along its axis. Almost all of these can be locked in two positions, allowing you to use them as either push or pull clamps.

- Imperial and metric internal threads
- Stainless steel and heavy-duty models
- Several mounting and plunger options available
- Variable stroke models available
- Destaco® Toggle Lock Plus.



70+ Models Available

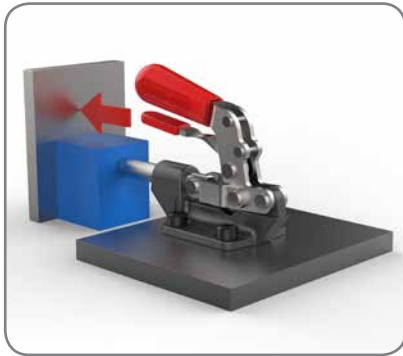

### Pull Action (Latch) Clamps

**Holding Capacities: 200lbf up to 7500lbf**

The handle is used to move and place the clamping pull bar (hook) around the opposing latch, then pulling back to reach the locked position. Ideal for sealing chamber doors or mold closures, this clamp provides a powerful closing force, positive holding and convenient single-handed operation.

- "J" hook and "U" hook type bars offered
- Stainless steel and heavy-duty models available
- Multiple mounting and hook length options
- Destaco® Toggle Lock Plus.



50+ Models Available

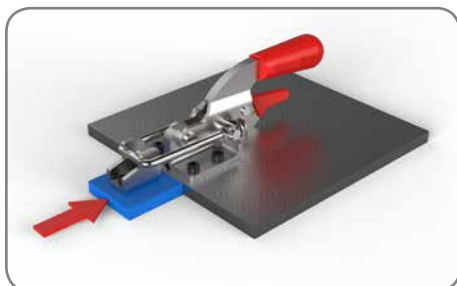

## Squeeze Action (Plier) Clamps

### Holding Capacities: 100lbf up to 1200lbf

These clamps are used wherever permanent or stationary clamping is not possible, making them a flexible clamping and fixturing solution. The clamp jaws lock automatically when closing, as one or both handles are squeezed against the central position. Some models feature the Destaco trigger release for easy one-hand opening.

- Drop forged, heat-treated alloy steel
- Several jaw types available
- Supplied with one or two adjustable spindles
- Swivel foot spindle available for angular surfaces



20+ Models Available

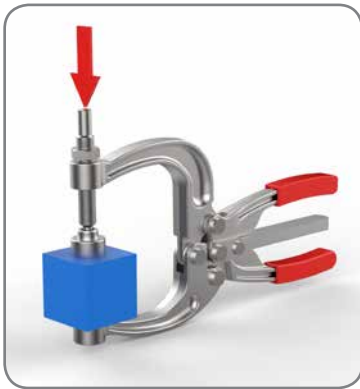

## Pneumatic Toggle Clamps

### Holding Capacities: 100lbf up to 16000lbf

Most of the products in this group are air-actuated, cylinder-driven versions of manual toggle clamps. They are ideal for quick and repetitive applications.

- Hold-down and straight-line action
- Solid and "U" bar clamping arms
- Low profile and compact models available for mounting in tight spaces.
- Heavy-duty models available
- Fully enclosed models available
- Sensor ready

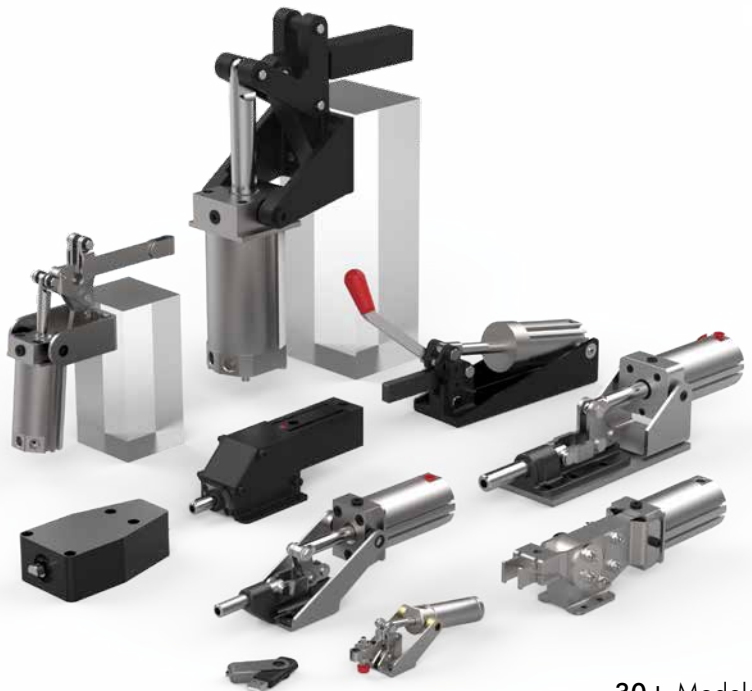

30+ Models Available

## Pneumatic Lever and Swing Clamps

### Clamping Force: Up to 321lbf

Swing clamps provide quick swing-and-clamp movement, where the clamping arm first pivots 90 degrees before drawing down on the workpiece.

The lever clamp arm pivots up and out of the way within its mounting footprint. All styles can be used to increase productivity while working in tight spaces.

- Several mounting and clamping arm options
- Right or left swing, or straight clamping action
- Threaded body options for through-hole mounting
- Models with constant clamping force over a range of part thickness available



30+ Models Available

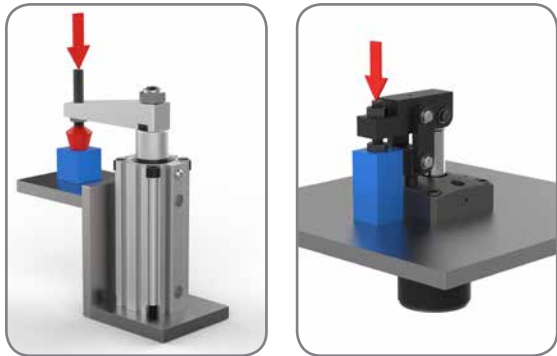

## Pneumatic Power Cylinders

### Clamping Power Force: Up to 13490lbf

Power cylinder operation is based on the wedge lever principle, using a double-acting, two-step stroke function. The forward stroke to move a certain distance and a power stroke providing an amplified force within a short distance.

- Maximum mechanical advantage up to 10:1
- Male threaded or female ISO fit rod end
- Optional end position control with magnetic field sensors
- Double piston rod design option prevents twisting during stroke



70+ Models Available



## Hydraulic Workholding Solutions

### Holding Capacities: Up to 12066 lbf

Hydraulic clamping products provide powered workholding solutions where greater clamping forces combined with fast, repeatable and reliable actuation is needed. When used with an air/oil booster, these solutions offer an affordable way to get the power of a hydraulic system with the use of existing shop air supply.

- Single and double-acting swing/pull clamps and threaded body cylinders
- Threaded body for through-hole mounting
- Thru-hole hydraulic rams can actuate a rod of any length or shape.
- Air/oil booster converts normal shop-line air pressure to high-pressure hydraulic power



25+ Models Available

## Pneumatic Round Bore Power Clamps

### Clamping Torque up to 420Nm

### Holding Torque up to 1800Nm

Designed for high production applications, these toggle action pneumatic clamps offer exceptional clamping forces and holding capacities - far greater than those of similar size. These clamps do not require greater pressure to open than to close.

- Clamp arms can be ordered in vertical or horizontal mount positions
- Mounting flexibility on all four sizes
- Magnetic sensing available



8 Models Available

**Pneumatic and Manual Power Clamps**

**Clamping Torque up to 850Nm  
Holding Torque up to 3000Nm**

Enclosed power clamp arms pivot down to position and hold product securely in place. The clamping mechanism is fully enclosed making these clamps ideal for use in harsh environments such as welding applications that demand superior clamping power.

- A complete full line of clamps from light-duty to heavy-duty models available
- Oval cylinder for space-saving slim body profile
- Several center “U” and lateral arms available
- Field adjustable arm opening angles
- Manual actuated and Hand lever option available
- Integrated open/closed sensing



11+ Families Available

**TCC-2 Tolerance Compensating Power Clamp Features**

- Tolerance compensation for variable sheet metal thicknesses within three degrees of arm movement
- There is no need for shimming

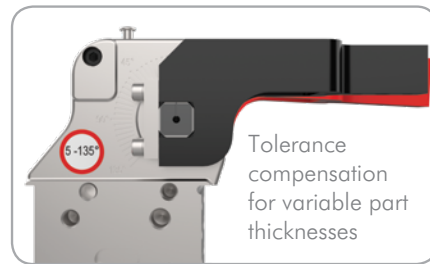

**82M-3E & TCC-2 Cylinder Options**

**Standard Cylinder**

Available for 82M and TCC Series Clamps



**Cylinder with Internal Hold Open Device**

Securely holds clamp in the open position  
Available for 82M and TCC Series Clamps



**Cylinder with Unlockable Return Valve**

Pneumatically holds clamp arm in the closed position when air is released

Only available for TCC Series Clamps

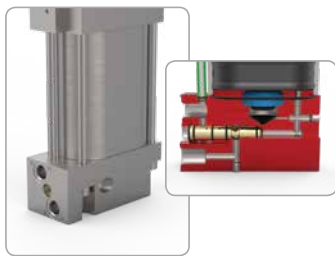

**Cylinder with Rod Locking Device**

Uses friction to clamp rod at any point between open and closed positions



## When an off-the-shelf product can't handle it - we can!.

With many years of experience working with OEM machine builders, we can make our product fit your unique application. We will partner with you to design the right product for your application – from altering an existing product to building a completely new product, we have the experience and expertise to help your project succeed.

Using our expertise to develop custom solutions for unique applications, Destaco helps you save time and resources, allowing you to focus on your core business and gain a competitive advantage in the marketplace.

- Proven quality from the experts
- Reduce risk by using our experienced engineers
- Easy reordering with unique part numbers
- Simplify your supply chain
- Three levels of customization from simple alterations to complex custom products

Model 330  
Standard Product



330-201 Stainless steel clamp with special hook and locking tab

Model 2002-U  
Standard Product



2002-200 with bar cut and bolt retainer welded on

Model 604  
Standard Product

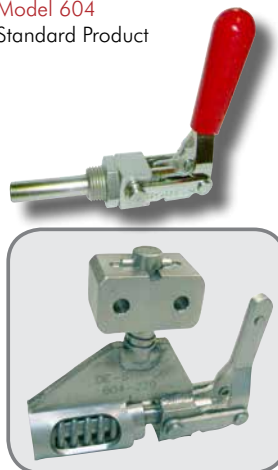

604-229 Stainless steel straight line clamp used in chemical machining process

Model 624/624-MM  
Standard Product



624-MM-872 with modified handle and square plunger

Model 202  
Standard Product



202-200 without grip, with imperial threaded spindle

Model 630-M  
Standard Product



630-38 with electroless nickel plating

Model 802-U  
Standard Product

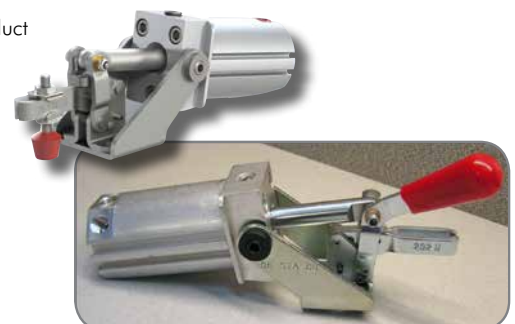

802-U219 with handle for manual operation



## GLOBAL LOCATIONS

### EUROPE

Germany  
Tel: +49-6171-705-0  
Customer Service: [europa@destaco.com](mailto:europa@destaco.com)

France  
Tel: +33-4-7354-5001  
Customer Service: [france@destaco.com](mailto:france@destaco.com)

Great Britain  
Tel: +44-1902-797980  
Customer Service: [uk@destaco.com](mailto:uk@destaco.com)

Spain  
Tel: +34-936361680  
Customer Service: [spain@destaco.com](mailto:spain@destaco.com)

Benelux  
Tel: +31-297285332  
Customer Service: [benelux@destaco.com](mailto:benelux@destaco.com)

### ASIA

Thailand  
Tel: +66-2-326-0812  
Customer Service: [info@destaco.com](mailto:info@destaco.com)

China  
Tel: +86-21-6081-2888  
Customer Service: [china@destaco.com](mailto:china@destaco.com)

India  
Tel: +91-80-41123421-426  
Customer Service: [india@destaco.com](mailto:india@destaco.com)

### NORTH AMERICA

**Corporate Headquarters**  
Auburn Hills, Michigan  
Toll Free: 1.888.DESTACO  
Marketing: [marketing@destaco.com](mailto:marketing@destaco.com)

**Global Technology Center**  
Auburn Hills, Michigan  
Tel: 1.248.836.6700  
Customer Service: [customerservice@destaco.com](mailto:customerservice@destaco.com)

Mt. Juliet, Tennessee  
Tel: 1.888.DESTACO  
Customer Service: [customerservice@destaco.com](mailto:customerservice@destaco.com)

Wheeling, Illinois  
Tel: 1.800.645.5207  
Customer Service: [camco@destaco.com](mailto:camco@destaco.com)

Red Wing, Minnesota (Central Research Laboratories)  
Tel: 651.385.2142  
Customer Service: [sales@centres.com](mailto:sales@centres.com)