

DLT SERIES - INTERNAL AIR CYLINDER

Internal Air Cylinder Linear Thruster Slides | Features and Benefits | How To Order

Features:

- 3 Models: **-B** block style, **-E** short body & **-L** long body
- Bearing system for smooth operation
- Rugged design produces very reliable long life operation
- Internal air cylinder for space-limited applications
- Urethane bumpers, hardened pads, oil wick
- Optional telescopic airlines transfers air to tooling
- DIRECTCONNECT™ mounting pattern
- Corrosion resistant shafting for corrosive environments
- Position sensing using inductive or magneto resistive sensors
- Viton® seals for high temperature applications

Applications:

- Machining, harsh environment, pick-and-place automation applications
- Lift table applications

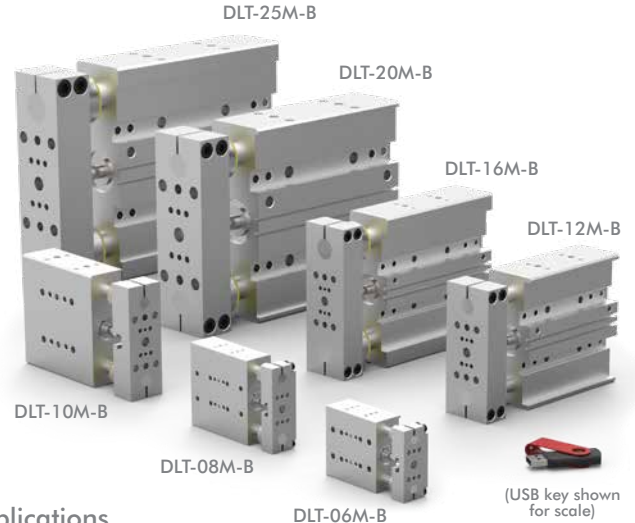

How To Order

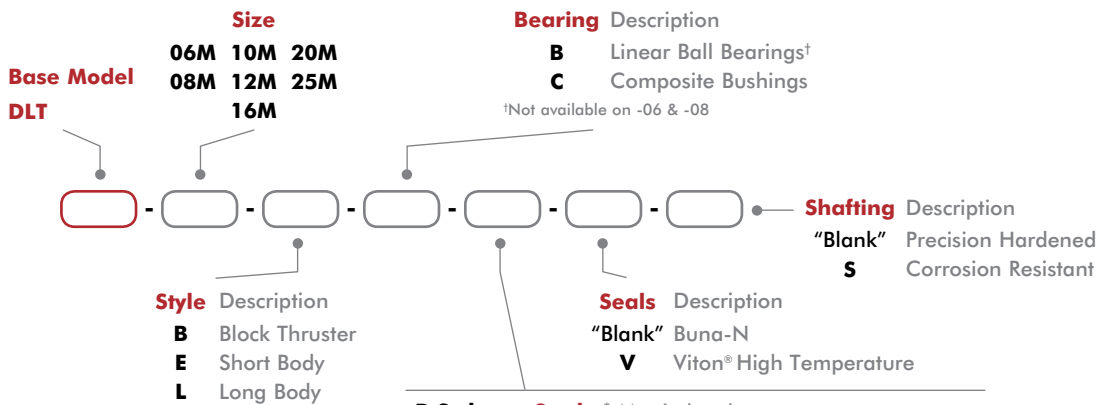

-B Style	Stroke* Metric (mm)
DLT-06M-B	6, 12, 25, 30
DLT-08M-B	6, 12, 25, 30, 40, 44
DLT-10M-B	12, 25, 40, 50
DLT-12M-B	12, 25, 40, 50
DLT-16M-B	12, 25, 40, 50, 65, 75
DLT-20M-B	12, 25, 40, 50, 65, 75, 85, 100
DLT-25M-B	12, 25, 40, 50, 65, 75, 85, 100, 115, 125
-E Style	Stroke* Metric (mm)
DLT-06M-E	6, 12, 25, 30
DLT-08M-E	6, 12, 25, 40, 44
DLT-10M-E	25, 50
DLT-12M-E	25, 50
DLT-16M-E	25, 50, 75
DLT-20M-E	25, 50, 75, 100
DLT-25M-E	25, 50, 75, 100, 125
-L Style	Stroke* Metric (mm)
DLT-06M-L	12, 25, 40, 50, 65, 75
DLT-08M-L	12, 25, 40, 50, 65, 75, 85
DLT-10M-L	25, 50, 80, 100
DLT-12M-L	25, 50, 80, 100, 125
DLT-16M-L	25, 50, 80, 100, 125, 150
DLT-20M-L	25, 50, 75, 100, 125, 160
DLT-25M-L	25, 50, 75, 100, 125, 160, 175

*Custom strokes available. Consult factory.

DLT SERIES - INTERNAL AIR CYLINDER

Internal Air Cylinder Linear Thruster Slides | Accessories

Shock/Stop & Mounting Accessories	Model Numbers	Style	Part Number	Qty/Unit
Universal Mounting Kit (Stop/Shock)	06	All	OSAK-069	1-2 on -B 1-4 on -E, -L
	08		OSAK-070	
Universal Mounting Kit (Stop/Shock/Sensor)	10		OSAK-055	
	12		OSAK-057	
	16		OSAK-059	
	20		OSAK-061	
	25		OSAK-063	
Shock Absorber	06, 08		SHOK-030	
	10		SHOK-028	
	12, 16,		SHOK-010	
	20, 25	SHOK-029		
Adjustable Hard Stop	06, 08	DLT-0623		
	10, 12, 16, 20, 25	DLT-1023		
Urethane Bumper/Stop Collar Kit	06	E, L	OSAK-067	1
	08		OSAK-068	
	10		OSAK-065	
	12		OSAK-066	
	16		OSAK-060	
	20		OSAK-062	
Base Flange Kit	25	OSAK-064		
	See Datasheet	B	--	

Sensor Accessories	Model Numbers	Style	Part Number	Qty/Unit	
Inductive Sensor Mounting Kit	06	All	OSMK-076	1 on -B 1-2 on -E, -L	
	08		OSMK-077		
PNP Inductive Sensor with Quick Disconnect*	06, 08		OISP-014		
NPN Inductive Sensor with Quick Disconnect*			OISN-014		
PNP Inductive Sensor with Quick Disconnect*	10, 12, 16, 20, 25		OISP-011		
NPN Inductive Sensor with Quick Disconnect*			OISN-011		
PNP Magneto Resistive with Quick Disconnect*	All Models		OHSP-017		1-2
NPN Magneto Resistive with Quick Disconnect*			OHSN-017		
Quick Disconnect 2 Meter Cable Length*	All Models		CABL-010		
Quick Disconnect 5 Meter Cable Length*			CABL-013		

*Sensor and cable sold separately.

Pneumatic Accessories	Model Numbers	Style	Part Number	Qty/Unit
G1/8 Telescopic Airlines (up to 50mm)	10, 12, 16	B, E	OTAL-043	1-4
G1/8 Telescopic Airlines (up to 80mm)		B, E, L	OTAL-044	
G1/8 Telescopic Airlines (up to 100mm)	20, 25	B, E	OTAL-051	
G1/8 Telescopic Airlines (up to 125mm)			OTAL-052	
G1/8 Telescopic Airlines (up to 160mm)	10, 12, 16	L	OTAL-045	
G1/8 Telescopic Airlines (up to 300mm)	20, 25		OTAL-046	
M5 Adjustable Flow Control	06, 08, 10, 12, 16	All	VLVF-008	1-2
G1/8 Adjustable Flow Control	20, 25		VLVF-005	
Seal Kits	See Datasheets			1

See page GR-LIN-36 for Accessory Mounting Technical Data.

DLT SERIES - INTERNAL AIR CYLINDER

Internal Air Cylinder Linear Thruster Slides | Technical Specifications

Specifications	Units	06-B, E	06-L	08-B, E	08-L	10-B, E	10-L	12-B, E	12-L
Max. Air Pressure	bar [psi]	7 [100]							
Thrust Force @ 5.5 bar [80psi]	N [lbs]	89 [20]				155 [35]		275 [62]	
Weight -B (basic unit)	kg [lb]	0.15 [0.34]	--	0.30 [0.65]	--	0.82 [1.81]	--	1.31 [2.88]	--
Weight -E, L (basic unit)	kg [lb]		0.28 [0.61]		0.44 [0.96]	0.84 [1.87]	0.88 [1.95]	1.35 [2.98]	1.46 [3.21]
Cylinder Bore Ø	mm [in]	14.3 [0.563]				19 [0.75]		25 [1.0]	
Shaft Ø	mm [in]	6 [0.236]		8 [0.315]		9.5 [0.375]		12 [0.472]	
Max (M) Vertical Motion	Nm [in-lbs]	0.6 [5]		1.1 [10]		2.8 [25]		5.6 [50]	

Specifications	Units	16-B, E	16-L	20-B, E	20-L	25-B, E	25-L
Max. Air Pressure	bar [psi]	7 [100]					
Thrust Force @ 5.5 bar [80psi]	N [lbs]	275 [62]			622 [140]		
Weight -B (basic unit)	kg [lb]	1.99 [4.38]	--	5.1 [11.6]	--	7.2 [15.7]	--
Weight -E, L (basic unit)	kg [lb]	2.07 [4.56]	2.03 [4.81]	5.2 [11.6]	5.5 [12.0]	7.4 [16.4]	7.9 [17.4]
Cylinder Bore Ø	mm [in]	25 [1.0]			38 [1.5]		
Shaft Ø	mm [in]	16 [0.630]		20 [0.787]		25 [0.984]	
Max (M) Vertical Motion	Nm [in-lbs]	11.3 [100]			28.2 [250]		56.4 [500]

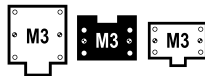

Internal Air Cylinder Linear Thruster Slides | Dimensions and Technical Specifications

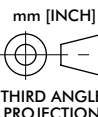
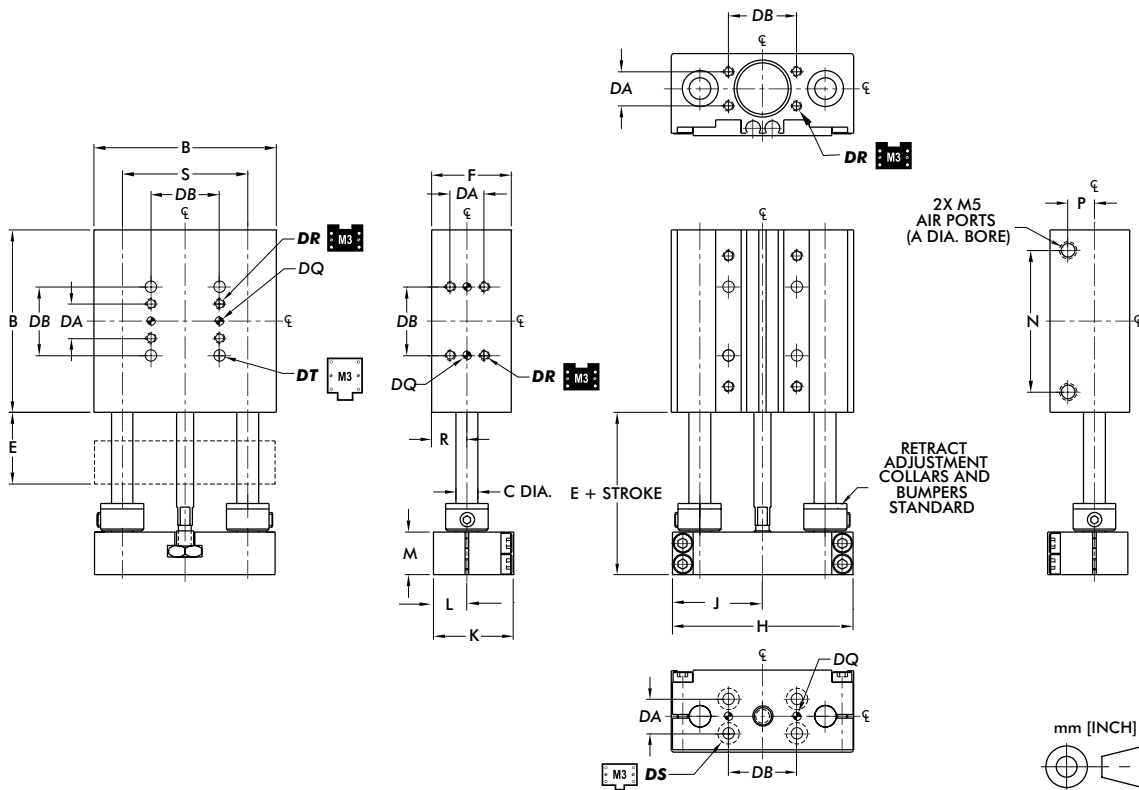

Pneumatic Accessories	Model	Part #	Qty/Unit
Cylinder Seal Kit (Buna-N)	ALL	SLKT-108	1
Cylinder Seal Kit (Viton®)		SLKT-108V	1

DIRECTCONNECT™ Mounting Pattern Dimensions (all sizes)

DA	DB	DQ	DR	DS	DT
9.5 [0.375]	19.1 [0.750]	3H7 X 2 DP	M3 x 6 DP	CLR & C'BORE FOR M3	CLR & C'BORE FOR M3

Model	Bore Ø	Body Size	Shaft Ø	Basic Unit Dimensions										
	A	B	C	E	F	H	J	K	L	M	N	P	R	S
DLT-06M	14 [0.563]	50.8 [2.00]	6.0 [0.236]	19.9 [0.783]	22.4 [0.88]	50.3 [1.980]	25.1 [0.990]	22.2 [0.875]	9.3 [0.365]	11.9 [0.470]	39.4 [1.55]	7.4 [0.29]	9.9 [0.390]	34.93 [1.375]
DLT-08M		63.5 [2.50]	8.0 [0.315]			62.7 [2.470]	31.0 [1.235]				52.1 [2.05]			44.45 [1.75]

Dimensions in mm [in]

Loading Information

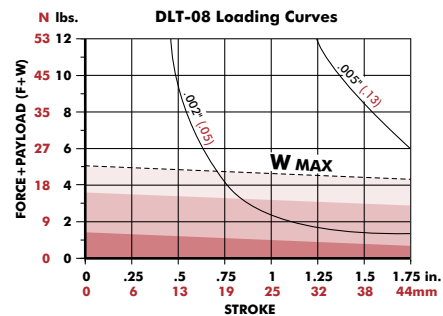
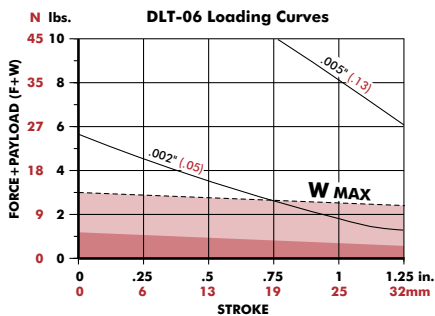

F=Externally applied force

W=Weight of payload

F+W=Total force

M=Maximum moment (in-lb. or N-m)

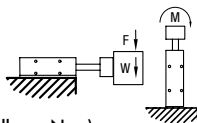

Shock Absorbers and Flow Controls are recommended for all applications

Use **Double Shocks** in both directions

Use **Single Shock** in both directions

Use **Bumpers or Cushioned Cylinder**

Shaded shock absorption ranges of horizontal payload (W) @ 80psi, flow controls fully open. For vertical applications do not exceed 1/2 of the recommended payload due to the additional acceleration effect of gravity.



Internal Air Cylinder Linear Thruster Slides | Dimensions and Technical Specifications

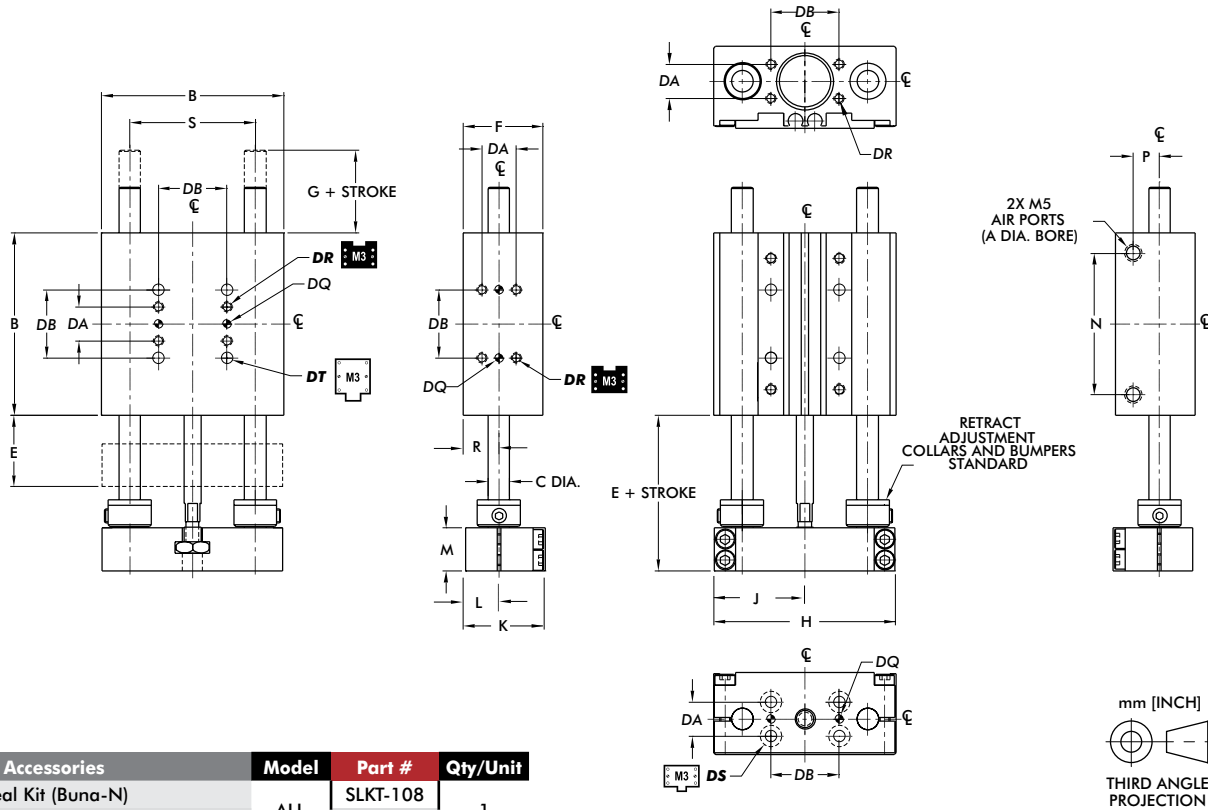

Pneumatic Accessories	Model	Part #	Qty/Unit
Cylinder Seal Kit (Buna-N)	ALL	SLKT-108	1
Cylinder Seal Kit (Viton®)		SLKT-108V	

DIRECTCONNECT™ Mounting Pattern Dimensions (all sizes)					
DA	DB	DQ	DR	DS	DT
9.5 [0.375]	19.1 [0.750]	3H7 X 2 DP	M3 x 6 DP	CLR & C'BORE FOR M3	CLR & C'BORE FOR M3

Model	Bore Ø Body Size Shaft Ø			Basic Unit Dimensions											
	A	B	C	E	F	G	H	J	K	L	M	N	P	R	S
DLT-06M	14 [0.563]	50.8 [2.00]	6.0 [0.236]	19.9 [0.783]	22.4 [0.88]	16.8 [0.66]	50.3 [1.980]	25.1 [0.990]	22.2 [0.875]	9.3 [0.365]	11.9 [0.470]	39.4 [1.55]	7.4 [0.29]	9.9 [0.390]	34.93 [1.375]
DLT-08M		63.5 [2.50]	8.0 [0.315]			10.4 [0.41]	62.7 [2.470]	31.0 [1.235]				52.1 [2.05]			44.45 [1.750]

Dimensions in mm [in]

Loading Information

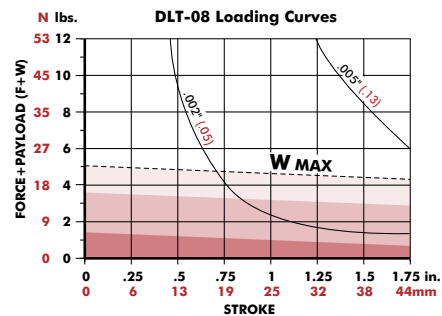
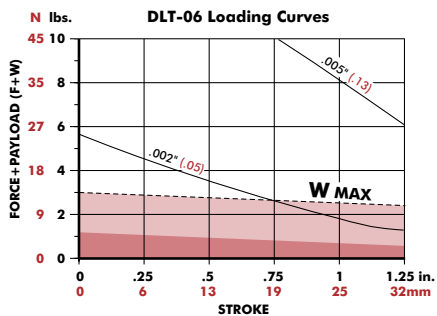

F=Externally applied force
 W=Weight of payload
 F+W=Total force
 M=Maximum moment (in-lb. or N-m)

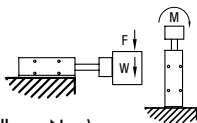

Shock Absorbers and Flow Controls are recommended for all applications

Use Double Shocks in both directions Use Single Shock in both directions Use Bumpers or Cushioned Cylinder

Shaded shock absorption ranges of horizontal payload (W) @ 80psi, flow controls fully open. For vertical applications do not exceed 1/2 of the recommended payload due to the additional acceleration effect of gravity.

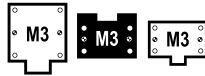

Internal Air Cylinder Linear Thruster Slides | Dimensions and Technical Specifications

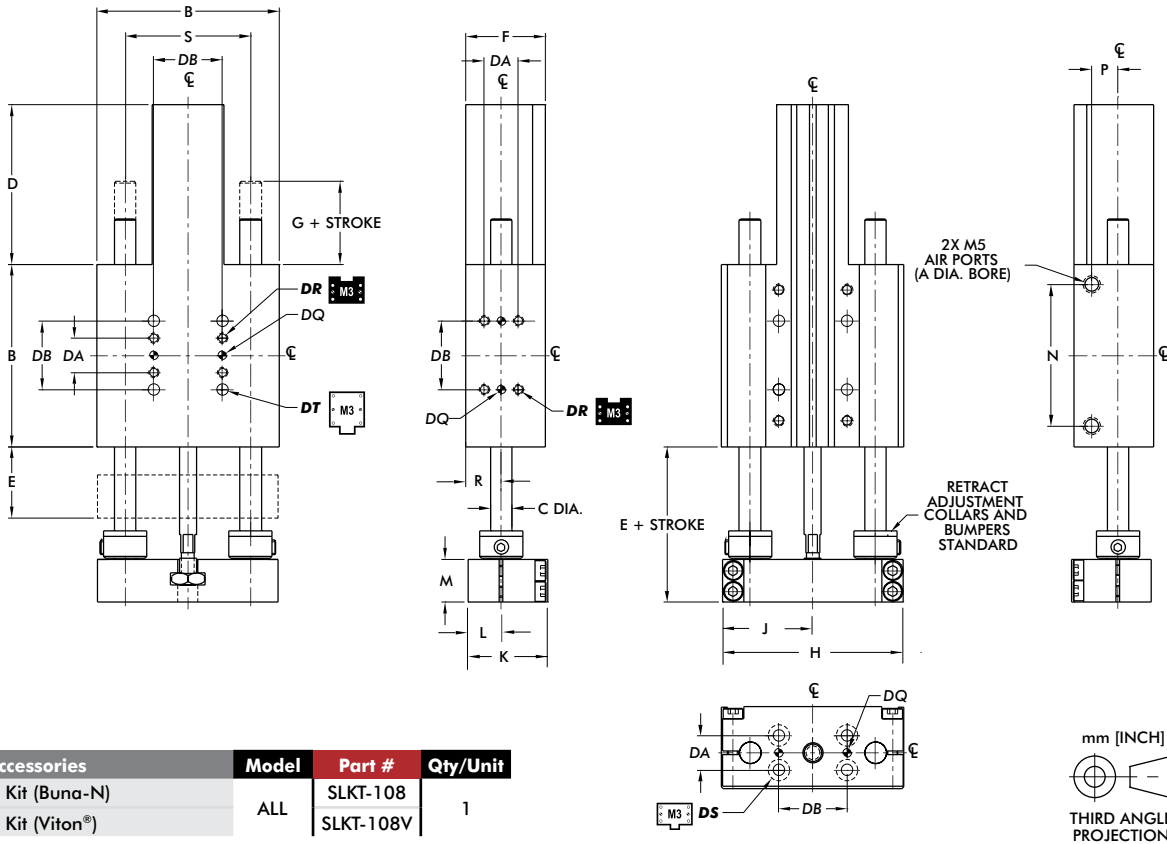

Pneumatic Accessories	Model	Part #	Qty/Unit
Cylinder Seal Kit (Buna-N)	ALL	SLKT-108	1
Cylinder Seal Kit (Viton®)		SLKT-108V	

DIRECTCONNECT™ Mounting Pattern Dimensions (all sizes)					
DA	DB	DQ	DR	DS	DT
9.5 [0.375]	19.1 [0.750]	3H7 X 2 DP	M3 x 6 DP	CLR & C'BORE FOR M3	CLR & C'BORE FOR M3

Model	Bore Ø	Body Size	Shaft Ø	Basic Unit Dimensions												
				A	B	C	D	E	F	G	H	J	K	L	M	N
DLT-06M	14 [0.563]	50.8 [2.00]	6.0 [0.236]	44.4 [1.75]	19.9 [0.783]	22.4 [0.88]	16.8 [0.66]	50.3 [1.980]	25.1 [0.990]	22.2 [0.875]	9.3 [0.365]	11.9 [0.470]	39.4 [1.55]	5.4 [0.21]	9.9 [0.390]	34.93 [1.375]
DLT-08M		63.5 [2.50]	8.0 [0.315]				10.4 [0.41]	62.7 [2.470]	31.0 [1.235]				52.1 [2.05]			44.45 [1.750]

Dimensions in mm [in]

Loading Information

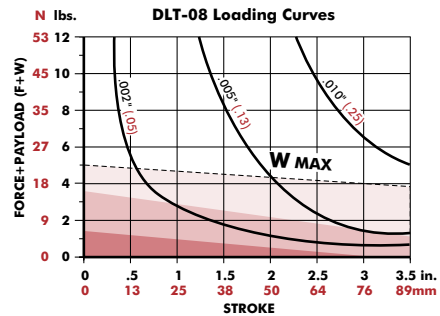
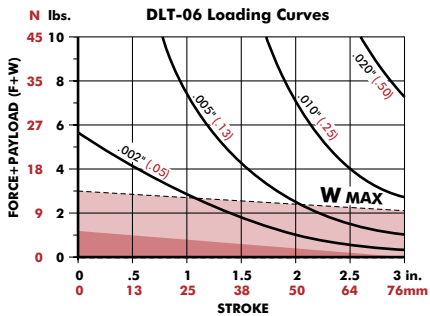

F=Externally applied force

W=Weight of payload

F+W=Total force

M=Maximum moment (in-lb. or N-m)

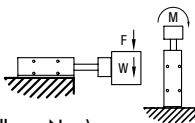

Shock Absorbers and Flow Controls are recommended for all applications

Use **Double Shocks** in both directions

Use **Single Shock** in both directions

Use **Bumpers or Cushioned Cylinder**

Shaded shock absorption ranges of horizontal payload (W) @ 80psi, flow controls fully open. For vertical applications do not exceed 1/2 of the recommended payload due to the additional acceleration effect of gravity.

DLT-10/12/16M-B

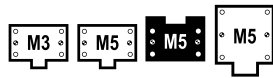

Internal Air Cylinder Linear Thruster Slides | Dimensions and Technical Specifications

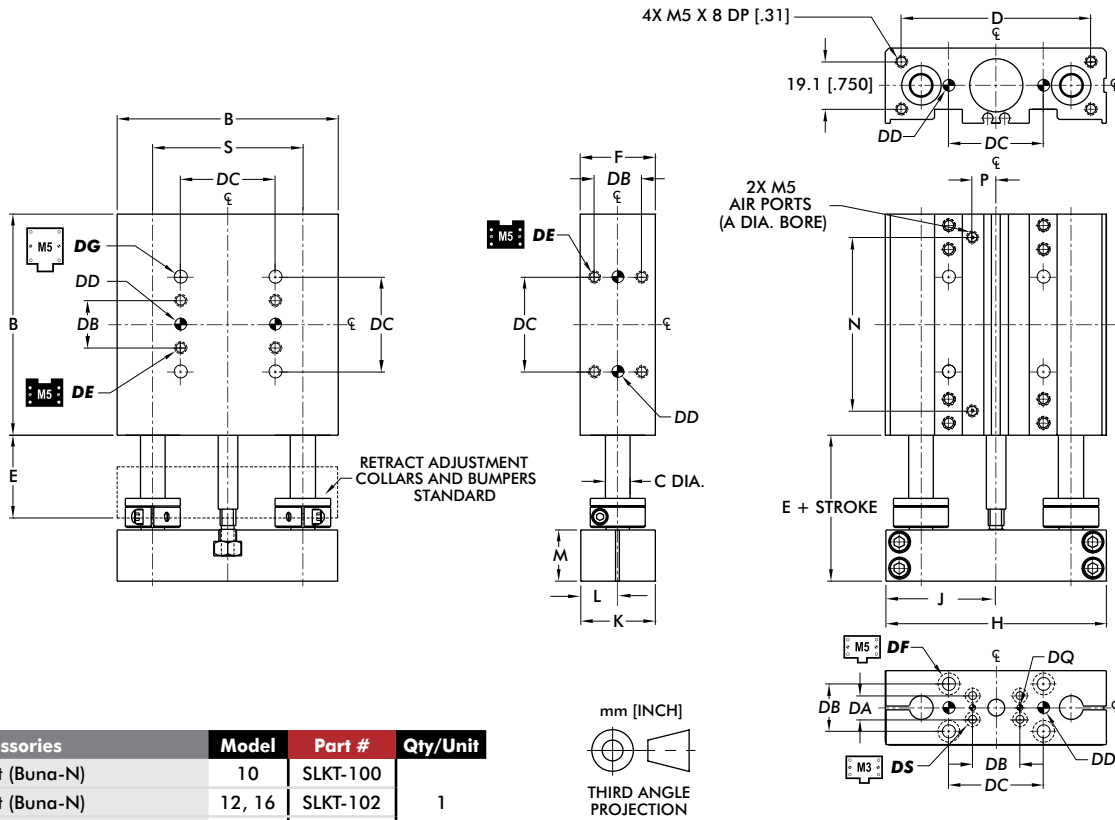

Pneumatic Accessories	Model	Part #	Qty/Unit
Cylinder Seal Kit (Buna-N)	10	SLKT-100	1
Cylinder Seal Kit (Buna-N)	12, 16	SLKT-102	
Cylinder Seal Kit (Viton®)	10	SLKT-100V	
Cylinder Seal Kit (Viton®)	12, 16	SLKT-102V	

DIRECTCONNECT™ Mounting Pattern Dimensions (all sizes)								
DA	DB	DC	DD	DE	DF	DG	DQ	DS
9.5 [0.375]	19.1 [0.750]	38.1 [1.500]	5mm H7 X 6 DP	M5 X 8.5 DP	CLEARANCE FOR M5	3H7 X 2 DP	CLR & C'BORE FOR M3	

Model	Basic Unit Dimensions			Basic Unit Dimensions												
	Bore Ø	Body Size	Shaft Ø	A	B	C	D	E	F	H	J	K	L	M	N	P
DLB-10M	19 [0.75]	88.9 [3.50]	9.5 [0.375]	76.2 [3.000]	33.4 [1.313]	30.2 [1.19]	88.6 [3.490]	44.2 [1.740]	29.9 [1.178]	14.8 [0.584]	20.7 [0.813]	69.7 [2.75]	9.4 [0.37]	60.33 [2.375]		
DLB-12M	25 [0.98]	101.6 [4.00]	12.0 [0.472]	92.1 [3.625]		41.4 [1.63]	101.2 [3.985]	50.4 [1.985]	41.0 [1.615]	20.4 [0.802]		83.3 [3.28]		69.85 [2.750]		
DLB-16M			120.7 [4.75]	16.0 [0.630]	111.1 [4.375]	34.9 [1.375]	120.3 [4.735]	59.9 [2.360]			102.4 [4.03]	82.55 [3.250]				

Dimensions in mm [in]

Loading Information

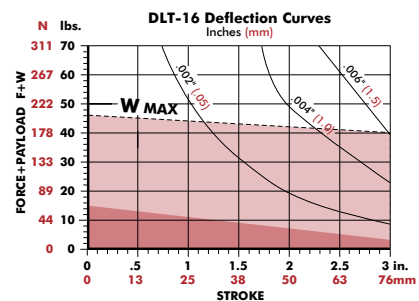
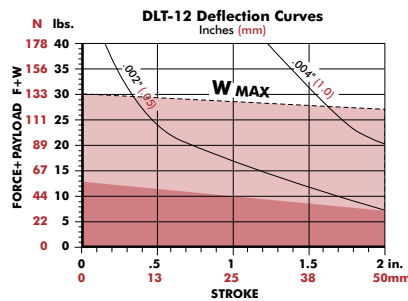
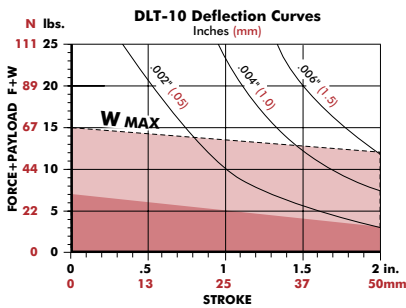

Shock Absorbers and Flow Controls are recommended for all applications

F=Externally applied force

W=Weight of payload

F+W=Total force

M=Maximum moment (in-lb. or N-m)

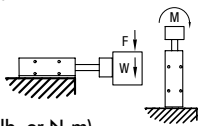

(W) in this range use Single Shock in retract directions

(W) in this range use Bumpers or Cushioned Cylinder

Shaded shock absorption ranges of horizontal payload (W) @ 80psi, flow controls fully open. For vertical applications do not exceed 1/2 of the recommended payload due to the additional acceleration effect of gravity.

Internal Air Cylinder Linear Thruster Slides | Dimensions and Technical Specifications

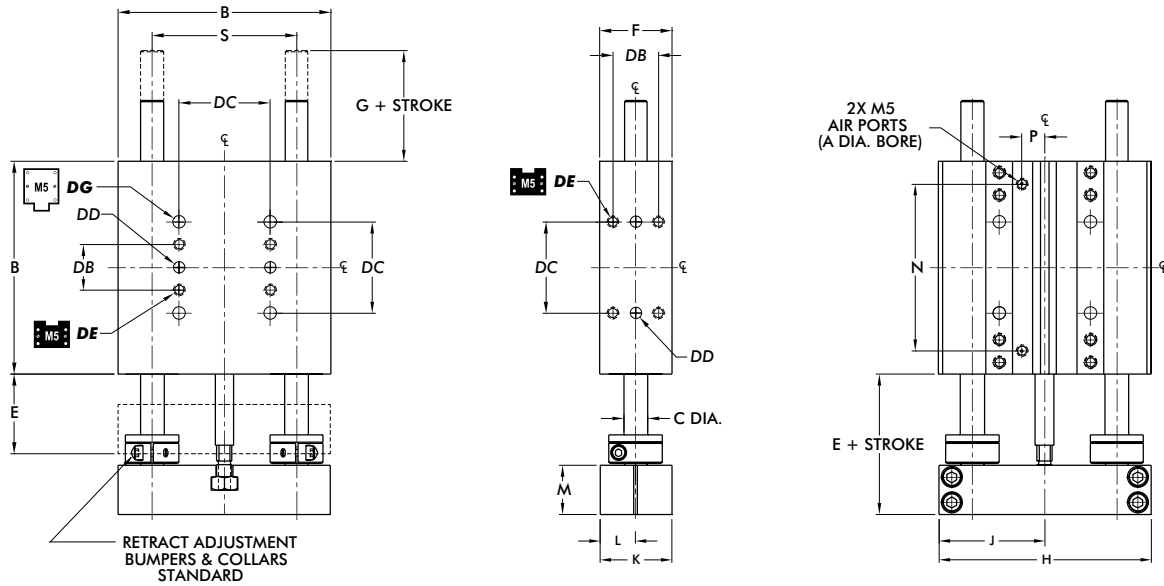

Pneumatic Accessories	Model	Part #	Qty/Unit
Cylinder Seal Kit (Buna-N)	10	SLKT-100	1
Cylinder Seal Kit (Buna-N)	12, 16	SLKT-102	
Cylinder Seal Kit (Viton®)	10	SLKT-100V	
Cylinder Seal Kit (Viton®)	12, 16	SLKT-102V	

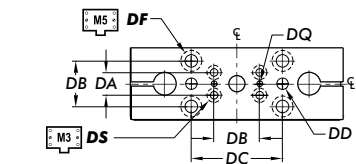
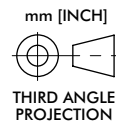

DIRECTCONNECT™ Mounting Pattern Dimensions (all sizes)								
DA	DB	DC	DD	DE	DF	DG	DQ	DS
9.5 [0.375]	19.1 [0.750]	38.1 [1.500]	5mm H7 X 6 DP	M5 X 8.5 DP	CLEARANCE FOR M5		3H7 X 2 DP	CLR & C'BORE FOR M3

Model	Bore Ø Body Size Shaft Ø			Basic Unit Dimensions											
	A	B	C	E	F	G	H	J	K	L	M	N	P	S	
DLB-10M	19 [3/4]	88.9 [3.50]	9.5 [0.375]	33.4 [1.313]	30.2 [1.19]	20.8 [0.82]	88.6 [3.490]	44.2 [1.740]	29.9 [1.178]	14.8 [0.584]	20.7 [0.813]	69.7 [2.75]	9.4 [0.37]	60.33 [2.375]	
DLB-12M	25 [1]	101.6 [4.00]	12.0 [0.472]		41.4 [1.63]		101.2 [3.985]	50.4 [1.985]	41.0 [1.615]	20.4 [0.802]		83.3 [3.28]		69.85 [2.750]	
DLB-16M		120.7 [4.75]	16.0 [0.630]	34.9 [1.375]	19.3 [0.76]	120.3 [4.735]	59.9 [2.360]	102.4 [4.03]	82.55 [3.250]						

Dimensions in mm [in]

Loading Information

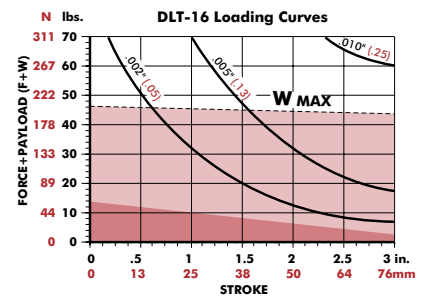
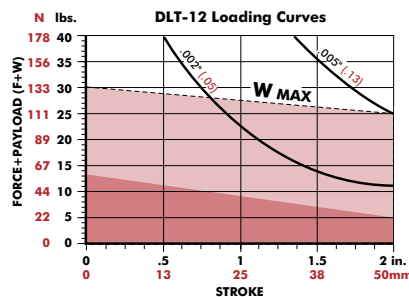
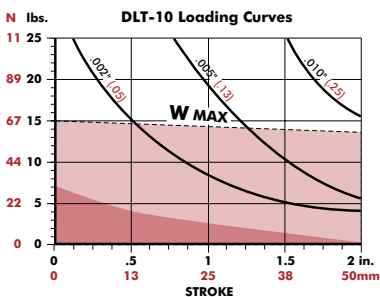

F=Externally applied force

W=Weight of payload

F+W=Total force

M=Maximum moment (in-lb. or N-m)

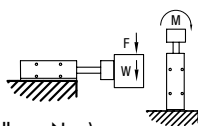

Shock Absorbers and Flow Controls are recommended for all applications

(W) in this range use **Single Shock** in retract directions

(W) in this range use **Bumpers or Cushioned Cylinder**

Shaded shock absorption ranges of horizontal payload (W) @ 80psi, flow controls fully open. For vertical applications do not exceed 1/2 of the recommended payload due to the additional acceleration effect of gravity.



Internal Air Cylinder Linear Thruster Slides | Dimensions and Technical Specifications

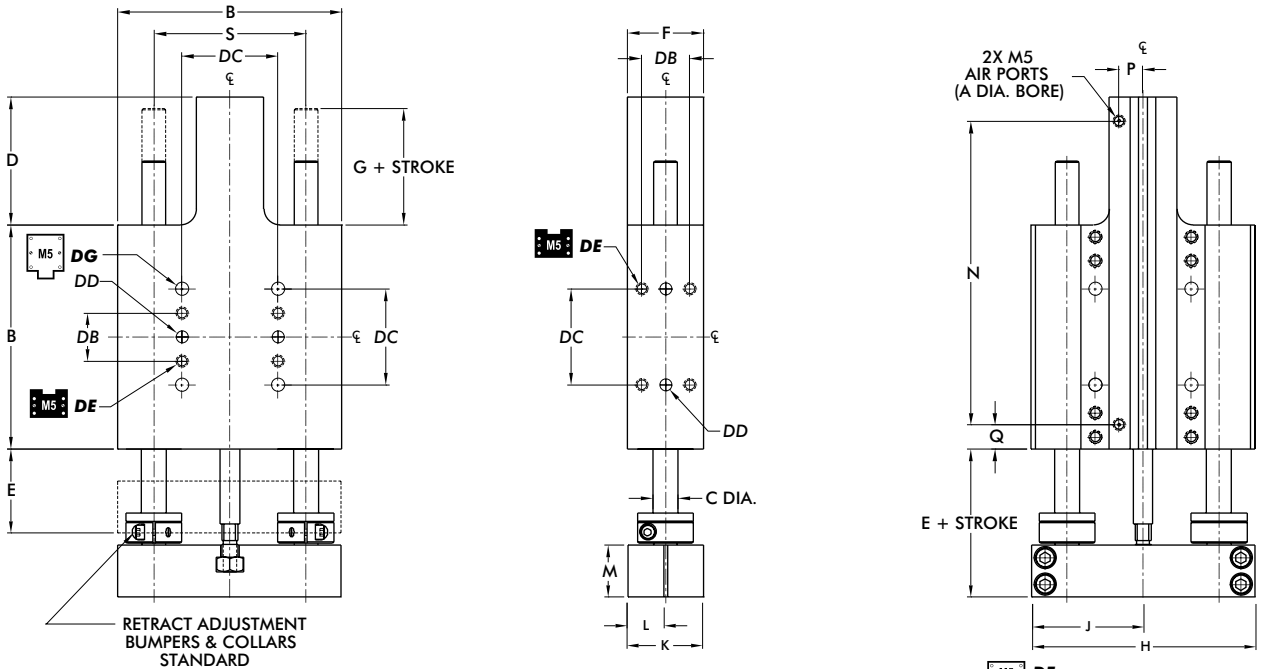

Pneumatic Accessories	Model	Part #	Qty/Unit
Cylinder Seal Kit (Buna-N)	10	SLKT-100	1
Cylinder Seal Kit (Buna-N)	12, 16	SLKT-102	
Cylinder Seal Kit (Viton®)	10	SLKT-100V	
Cylinder Seal Kit (Viton®)	12, 16	SLKT-102V	

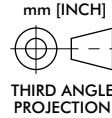

DIRECTCONNECT™ Mounting Pattern Dimensions (all sizes)								
DA	DB	DC	DD	DE	DF	DG	DQ	DS
9.5 [0.375]	19.1 [0.750]	38.1 [1.500]	5mm H7 X 6 DP	M5 X 8.5 DP	CLEARANCE FOR M5		3H7 X 2 DP	CLR & C'BORE FOR M3

Model	Bore Ø	Body Size	Shaft Ø	Basic Unit Dimensions												
				A	B	C	D	E	F	G	H	J	K	L	M	N
DLB-10M	19 [3/4]	88.9 [3.50]	9.5 [0.375]	50.8 [2.00]	33.4 [1.313]	30.2 [1.19]	20.8 [0.82]	88.6 [3.490]	44.2 [1.740]	29.9 [1.178]	14.8 [0.584]		120.7 [4.75]	9.6 [0.38]	9.6 [0.38]	60.33 [2.375]
DLB-12M	25 [1]	101.6 [4.00]	12.0 [0.472]	63.5 [2.50]	41.4 [1.63]			101.2 [3.985]	50.4 [1.985]	41.0 [1.615]	20.4 [0.802]	20.7 [0.813]	146.8 [5.78]	9.4 [0.37]	9.1 [0.36]	69.85 [2.750]
DLB-16M		120.7 [4.75]	16.0 [0.630]	69.9 [2.75]				34.9 [1.375]	19.3 [0.76]				120.3 [4.735]			59.9 [2.360]

Dimensions in mm [in]

Loading Information

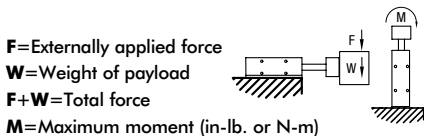
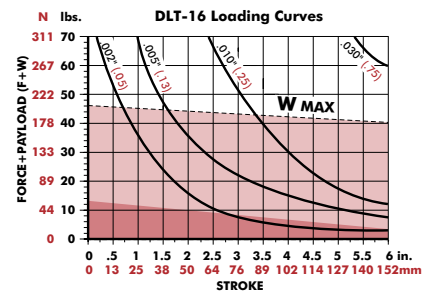
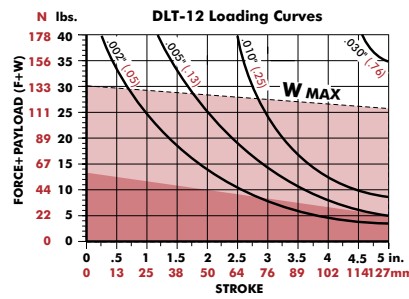
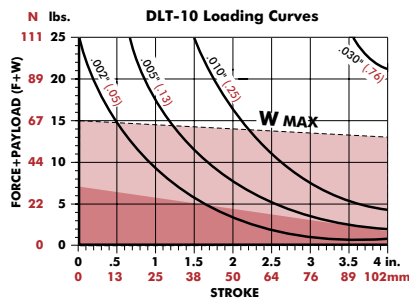

Shock Absorbers and Flow Controls are recommended for all applications

(W) in this range use **Single Shock** in retract directions (W) in this range use **Bumpers or Cushioned Cylinder**

Shaded shock absorption ranges of horizontal payload (W) @ 80psi, flow controls fully open. For vertical applications do not exceed 1/2 of the recommended payload due to the additional acceleration effect of gravity.

Internal Air Cylinder Linear Thruster Slides | Dimensions and Technical Specifications

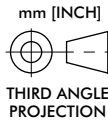
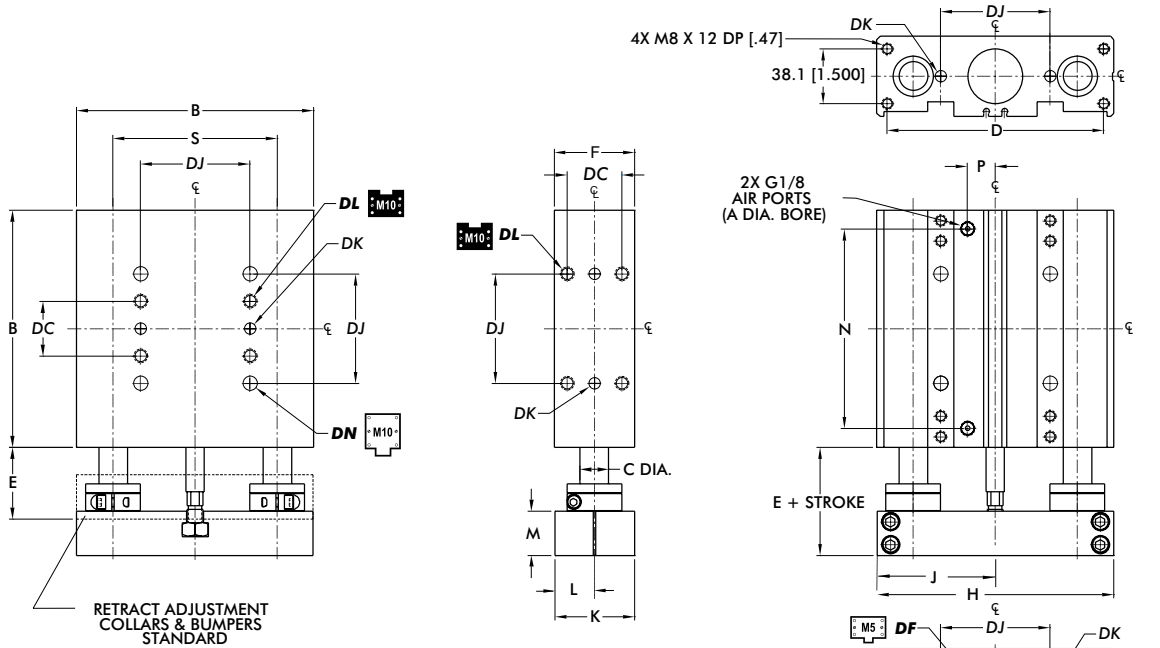

Pneumatic Accessories	Model	Part #	Qty/Unit
Cylinder Seal Kit (Buna-N)	20	SLKT-104	1
Cylinder Seal Kit (Viton®)	25	SLKT-104V	1

DIRECTCONNECT™ Mounting Pattern Dimensions (all sizes)									
DB	DC	DD	DF	DJ	DK	DL	DM	DN	
19.1 [0.750]	38.1 [1.500]	5mm H7 X 6 DP	CLEARANCE FOR M5	76.2 [3.000]	8mm H7 x 9.4 DP	M10 x 14.2 DP	CLR & C'BORE FOR M10		

Model	Bore Ø	Body Size	Shaft Ø	Basic Unit Dimensions										
				A	B	C	D	E	F	H	J	K	L	M
DLB-20M	38 [1 1/2]	165.1 [6.50]	20 [0.787]	150.8 [5.938]	49.8 [1.960]	55.9 [2.20]	164.6 [6.480]	82.0 [3.230]	55.4 [2.180]	27.4 [1.080]	30.7 [1.210]	138.9 [5.47]	19.5 [0.77]	114.30 [4.500]
DLB-25M		190.5 [7.50]	25 [0.984]	176.2 [6.938]	55.1 [2.170]		190.0 [7.480]	94.7 [3.730]			36.1 [1.420]	164.3 [6.47]		

Dimensions in mm [in]

Loading Information

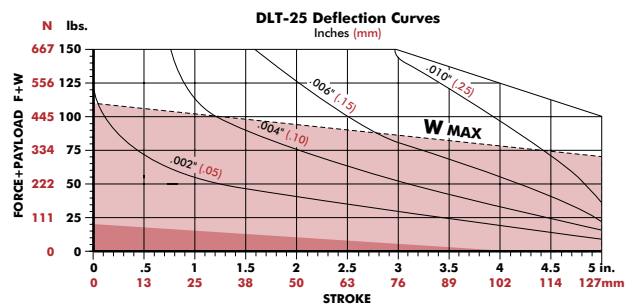
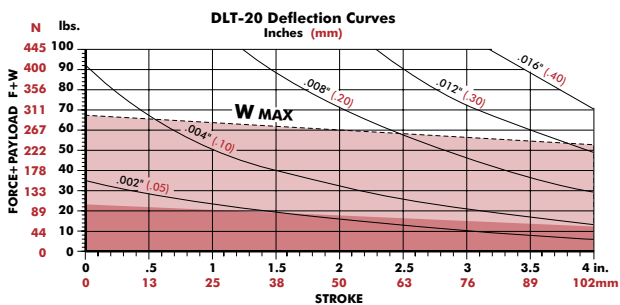

F=Externally applied force

W=Weight of payload

F+W=Total force

M=Maximum moment (in-lb. or N-m)

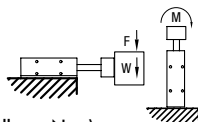

Shock Absorbers and Flow Controls are recommended for all applications

(W) in this range use **Single Shock** in retract directions

(W) in this range use **Bumpers or Cushioned Cylinder**

Shaded shock absorption ranges of horizontal payload (W) @ 80psi, flow controls fully open. For vertical applications do not exceed 1/2 of the recommended payload due to the additional acceleration effect of gravity.



Internal Air Cylinder Linear Thruster Slides | Dimensions and Technical Specifications

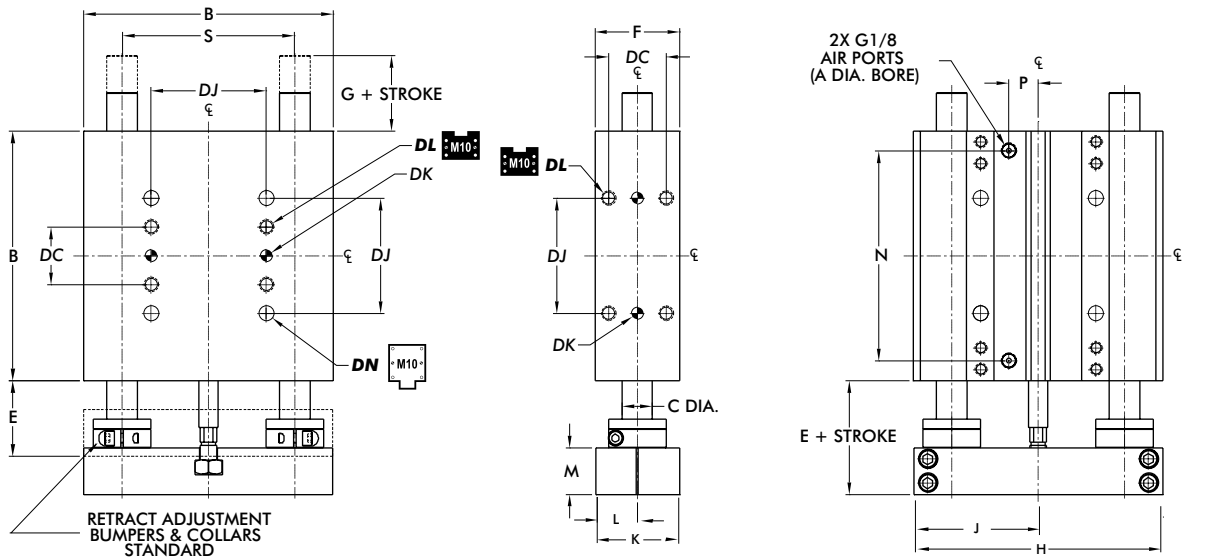

RETRACT ADJUSTMENT BUMPERS & COLLARS STANDARD

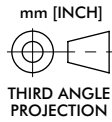

Pneumatic Accessories	Model	Part #	Qty/Unit
Cylinder Seal Kit (Buna-N)	20	SLKT-104	1
Cylinder Seal Kit (Viton®)	25	SLKT-104V	1

DIRECTCONNECT™ Mounting Pattern Dimensions (all sizes)									
DB	DC	DD	DF	DJ	DK	DL	DM	DN	
19.1 [0.750]	38.1 [1.500]	5mm H7 X 6 DP	CLEARANCE FOR M5	76.2 [3.000]	8mm H7 x 9.4 DP	M10 x 14.2 DP	CLR & C'BORE FOR M10		

Model	Bore Ø	Body Size	Shaft Ø	Basic Unit Dimensions											
				A	B	C	E	F	G	H	J	K	L	M	N
DLT-20M	38	165.1 [6.50]	20 [0.787]	49.8 [1.960]	55.9 [2.20]	24.4 [0.960]	164.6 [6.480]	82.0 [3.230]		55.4 [2.180]	27.4 [1.080]	30.7 [1.210]	138.9 [5.47]	19.5 [0.77]	114.30 [4.300]
DLT-25M	[1 1/2]	190.5 [7.50]	25 [0.984]	55.1 [2.170]		29.7 [1.170]	190.0 [7.480]	94.7 [3.730]				36.1 [1.420]	164.3 [6.47]		133.35 [5.250]

Dimensions in mm [in]

Loading Information

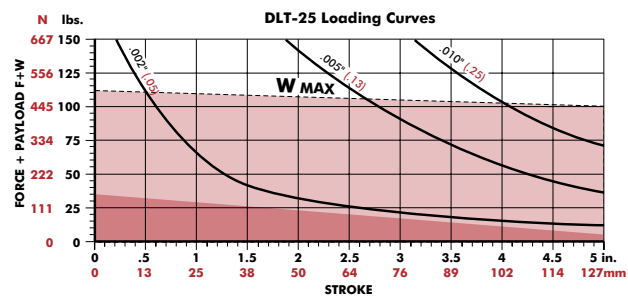
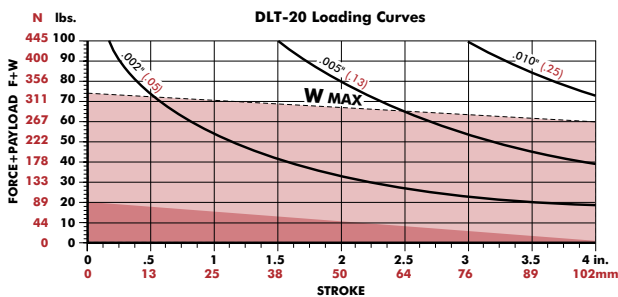

F=Externally applied force
W=Weight of payload
F+W=Total force
M=Maximum moment (in-lb. or N-m)

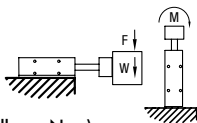

Shock Absorbers and Flow Controls are recommended for all applications

(W) in this range use **Single Shock** in retract directions (W) in this range use **Bumpers or Cushioned Cylinder**

Shaded shock absorption ranges of horizontal payload (W) @ 80psi, flow controls fully open. For vertical applications do not exceed 1/2 of the recommended payload due to the additional acceleration effect of gravity.

Internal Air Cylinder Linear Thruster Slides | Dimensions and Technical Specifications

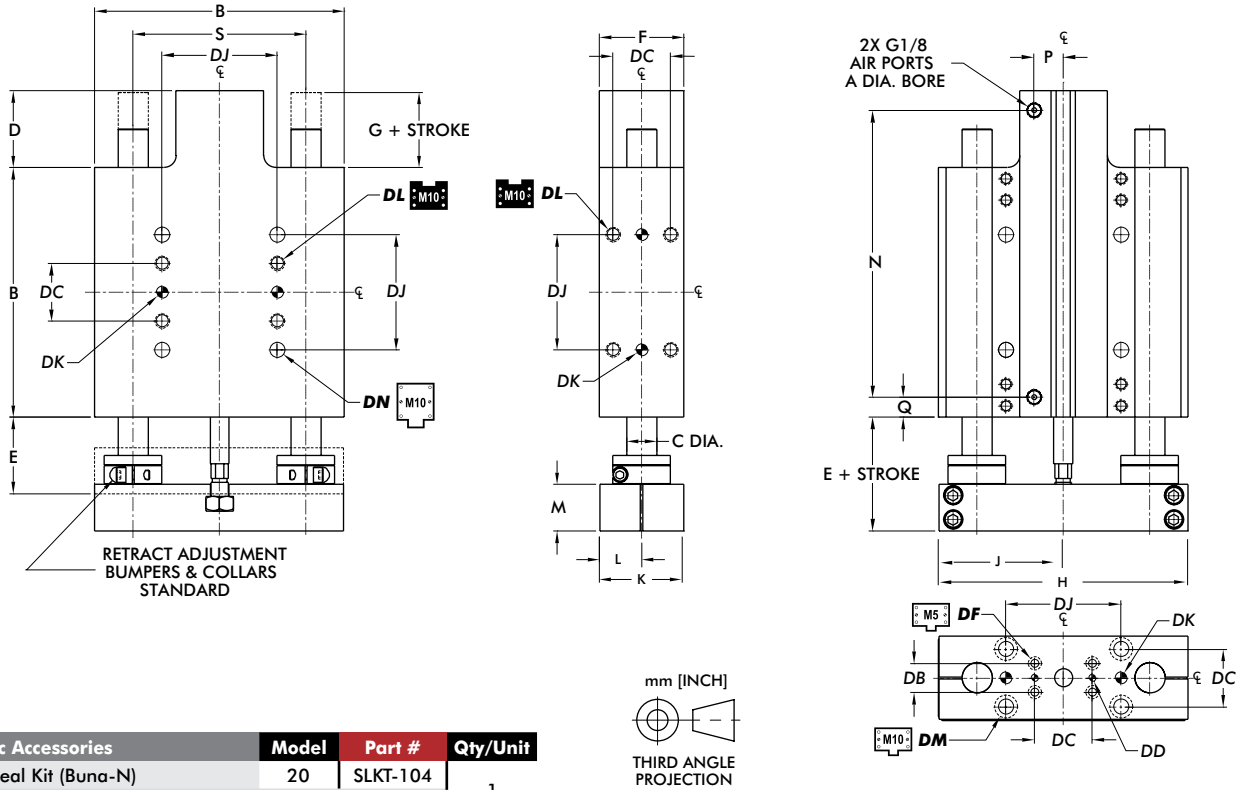

Pneumatic Accessories	Model	Part #	Qty/Unit
Cylinder Seal Kit (Buna-N)	20	SLKT-104	1
Cylinder Seal Kit (Viton®)	25	SLKT-104V	1

DIRECTCONNECT™ Mounting Pattern Dimensions (all sizes)									
DB	DC	DD	DF	DJ	DK	DL	DM	DN	
19.1 [0.750]	38.1 [1.500]	5mm H7 X 6 DP	CLEARANCE FOR M5	76.2 [3.000]	8mm H7 x 9.4 DP	M10 x 14.2 DP	CLR & C'BORE FOR M10		

Model	Bore Ø	Body Size	Shaft Ø	Basic Unit Dimensions												
				A	B	C	D	E	F	G	H	J	K	L	M	N
DLT-20M	38 [1 1/2]	165.1 [6.50]	20 [0.787]	50.8 [2.00]	49.8 [1.960]	55.9 [2.20]	24.4 [0.960]	164.6 [6.480]	82.0 [3.230]	55.4 [2.180]	27.4 [1.080]	30.7 [1.210]	189.7 [7.469]	19.4 [0.77]	13.1 [0.52]	114.30 [4.500]
DLT-25M		190.5 [7.50]	25 [0.984]									29.7 [1.170]	190.0 [7.480]			

Dimensions in mm [in]

Loading Information

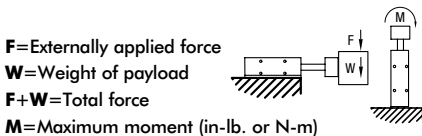
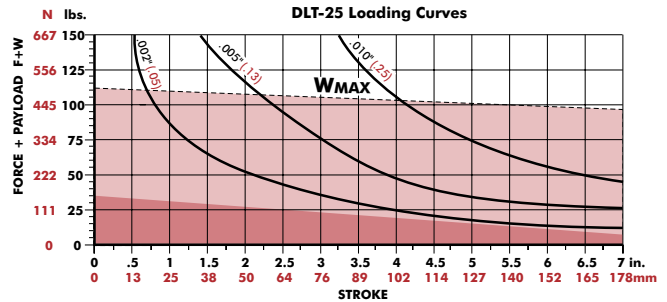
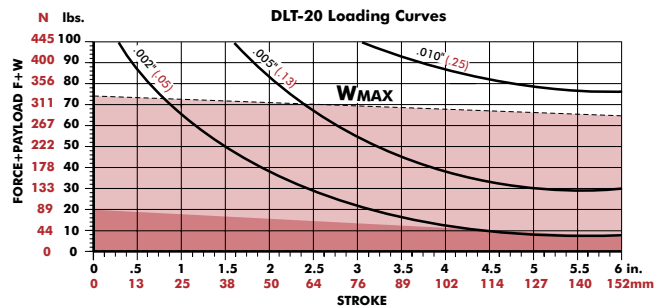

Shock Absorbers and Flow Controls are recommended for all applications

(W) in this range use **Single Shock** in retract directions (W) in this range use **Bumpers or Cushioned Cylinder**

Shaded shock absorption ranges of horizontal payload (W) @ 80psi, flow controls fully open. For vertical applications do not exceed 1/2 of the recommended payload due to the additional acceleration effect of gravity.