

Industry Gearboxes



Maintenance and Repair

GEARBOX MAINTENANCE, REPAIR AND SERVICE

ALL BRANDS | TYPES

In the event of machine downtime or machine failure, a quick and cost-effective solution must be found. It is important to have a competent and reliable partner for the repair, renewal and maintenance of industrial gearboxes.

We are your competent partner for all manufacturers transmission repairs. We ensure a fast, inexpensive and professional repair, so that your system is ready for use again at short notice.

We determine the exact cause of the damage and offer individual maintenance and service concepts.

EMERGENCY SERVICE



+49 (0)7751 / 8731-16
service@flohri-industrietechnik.de

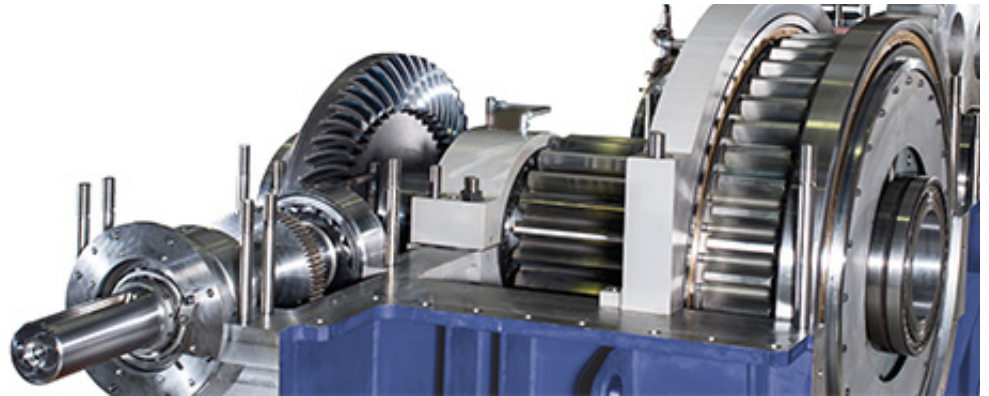

Our services

- Brand-independent repair / maintenance of transmissions
- Professional installation and removal service at the customer's premises
- Fast and professional damage analysis
- Fixed cost estimate for the repair
- In house mechanical production
- Using original parts or parts of equivalent quality
- Customised spare parts storage
- Balancing and alignment service
- Load testing on our in house testing facility
- Guarantee on all of our services
- Individual maintenance and service concepts available

Regardless of the gearbox manufacturer and type we have well-founded know-how in

- Lifting gears
- Flat gears
- Large gears
- Bevel gears
- Planetary gears
- Precision gears
- Special gears
- Worm gears
- Step-driven
- Spur gears
- Angular gears
- Cycloidal gears

In-house mechanical production

Whether housings, gearing parts, shafts or other elements need to be manufactured or overhauled, we will quickly and competently take care of a solution to your drive problem. In doing so, we ensure short downtimes and a long service life. For an overview of contract manufacturing, we will be happy to send you our current machine list.

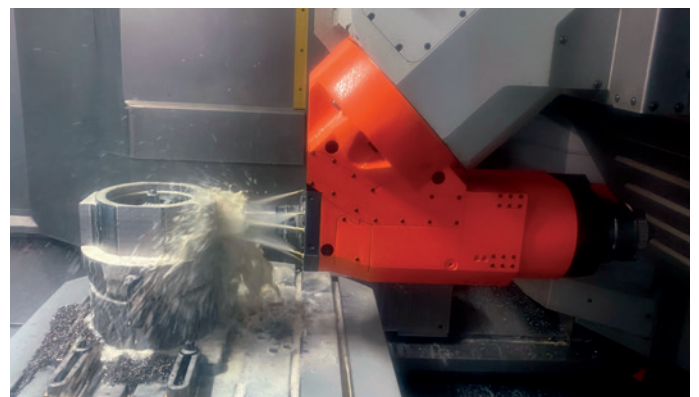

FAST. RELIABLE. COMPETENT.

In many cases a gearbox repair is the quicker and more economical solution. You will receive an informative damage report from us with an offer. On this basis, you decide between a new gearbox or a repair.

More than 50 years of experience in the assembly of gearboxes and components speaks for itself. Our team has a lot of experience and know-how to carry out assembly and repair work regardless of the brand, type or year of manufacture. Our gearboxes are in use worldwide and are characterized by their reliability.

The assembly of our own gearboxes is part of our daily business. Every move is spot on here and the quality and performance of our employees makes us proud. We have excellent references both for the automotive industry and in the field of classic drive technology. We would be happy to put our options at your service.

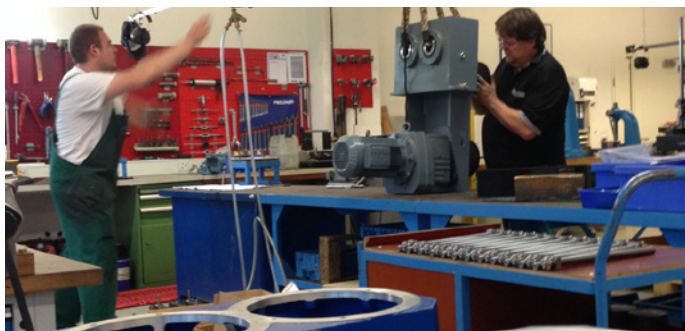

Repair

Whether for a short-term emergency replacement or for the comprehensive replacement of the entire drive unit during a planned downtime: With our modern tooling systems, we guarantee efficient and above all safe processing of customer orders on site or in our factory.

Our services:

- Failure analysis
- Transmission maintenance / Revision
- Technical modifications / Optimization
- Reconstruction of transmission components
- Quality control
- Vulnerability analysis and elimination
- Exchange transmission / Spare parts

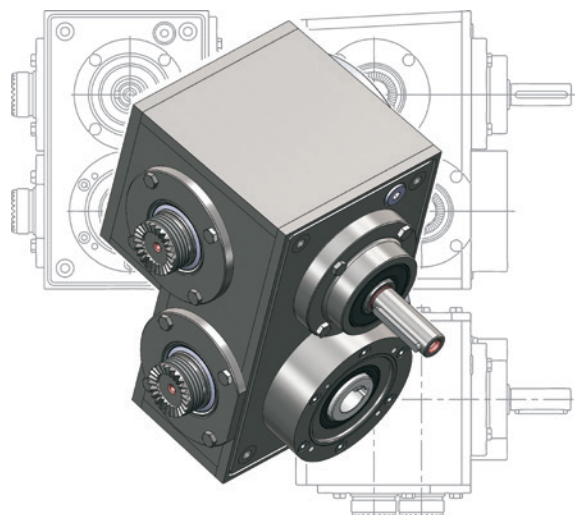

Damage Analysis

The basis of a gearbox repair is always the detailed analysis of the gearbox elements. In this way, we can guarantee high cost transparency and professional processing right from the start. In doing so, we create precise analysis of the condition of the gearbox and can thus identify problems or damage at an early stage. We develop individual concepts for you so that your system is ready for use again quickly and for the long term.

Damage assessment in detail:

- Disassembly and cleaning of all transmission parts
- Analysis of all transmission elements
- Including all of the defective parts
- Determination of gear geometries and materials
- Creation of an error report including a cost estimate for the repair

After approval for repairs, we refurbish the reusable components and replace the wearing parts. Finally, the overhauled gearbox is subjected to complete checking and test runs. In this way we can guarantee perfect function.



CONSTRUCTION & DEVELOPMENT

Development of transmission prototypes and components.
How can we support you?

FLOHR - PRODUCTS OVERVIEW

Gears

- Spiral toothed bevel gears
- Bevel gears
- Worm gears
- Spur gears
- Special gears



Gear Technology

- Bevel gearboxes
- Angle-planetary gearboxes
- Worm gearboxes
- Cam drives and indexing units
- Cam components
- Special gearboxes

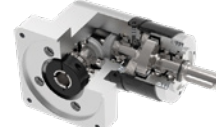

Couplings

- Rigid and flexible couplings
- Frictional connections
- Drum-coupling
- Gear-couplings
- Safety couplings

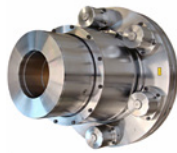

Friction connections

- Shrink discs
- Shaft couplings
- Flange couplings
- Locking units

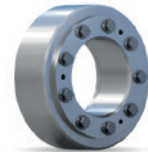

Clamping technology

- Manual and pneumatic clamping solutions
- Power clamps
- Pivot units
- End effector solutions
- Linear units
- Grippers



Belt drives

- V-belt and flat belt pulleys
- Flywheels
- Special pulleys
- Motor clamping systems
- Drive belts
- Customer designed castings
- Accessories



Sensor systems

- Incremental encoders
- Magnetic encoders
- Absolute encoders
- Electronic overspeed switches
- Electronic position switches
- Universal encoder systems
- Systems



Contract manufacturing

- Turning, milling, grinding
- Grooving and broaching
- Balancing
- Calculation and design
- Assembly
- Service and repair



 **FLOHR**
INDUSTRIE TECHNIK GMBH

FLOHR Germany

FLOHR INDUSTRIE TECHNIK GmbH
Im Unteren Tal 1
D-79761 Waldshut-Tiengen
Phone: +49 (0) 77 51 / 87 31 0
info@flohr-industrietechnik.de
www.flohr-industrietechnik.de

FLOHR Switzerland

FLOHR INDUSTRIE TECHNIK
Zilistude 164
CH-5465 Mellikon
Phone: +41 (0) 56 / 267 08 10
info@flohr.ch
www.flohr.ch

FLOHR Austria

FLOHR INDUSTRIE TECHNIK
Bucherstraße 37b
A-6922 Wolfurt
Phone: +43 (0) 5572 / 372 158
info@flohr.at
www.flohr.at